



Dell™ Latitude™ E6400 XFR

Service Manual

Notes, Notices, and Cautions

 **NOTE:** A NOTE indicates important information that helps you make better use of your computer.

 **NOTICE:** A NOTICE indicates either potential damage to hardware or loss of data and tells you how to avoid the problem.

 **CAUTION:** A CAUTION indicates a potential for property damage, personal injury, or death.

Information in this document is subject to change without notice.

© 2009 Dell Inc. All rights reserved.

Reproduction of these materials in any manner whatsoever without the written permission of Dell Inc. is strictly forbidden.

Trademarks used in this text: *Dell*, *Latitude*, and the *DELL* logo are trademarks of Dell Inc.; *Bluetooth* is a registered trademark owned by Bluetooth SIG, Inc. and is used by Dell under license; *Intel* is a registered trademark of Intel Corporation in the U.S. and other countries; *Microsoft*, *Windows*, *Windows Vista* and the *Windows Vista* start button are either trademarks or registered trademarks of Microsoft Corporation in the United States and/or other countries.

Other trademarks and trade names may be used in this document to refer to either the entities claiming the marks and names or their products. Dell Inc. disclaims any proprietary interest in trademarks and trade names other than its own.

February 2009. Rev. A00

Table of Contents

| | |
|---|-----------|
| 1 TROUBLESHOOTING | 7 |
| 1.1 TROUBLESHOOTING TOOLS | 7 |
| 1.1.1 Diagnostic Lights | 7 |
| 1.1.2 Hardware Troubleshooter | 8 |
| 1.1.3 Dell Diagnostics | 8 |
| 1.1.4 Error Messages | 12 |
| 1.2 SOLVING PROBLEMS | 12 |
| 1.2.1 Battery Problems | 13 |
| 1.2.2 Drive Problems | 13 |
| 1.2.3 IEEE 1394 Device Problems | 14 |
| 1.2.4 Lockups and Software Problems | 14 |
| 1.2.5 Memory Problems | 16 |
| 1.2.6 Power Problems | 16 |
| 1.2.7 Sound and Speaker Problems | 16 |
| 1.2.8 Video and Display Problems | 17 |
| 1.3 DELL TECHNICAL UPDATE SERVICE | 17 |
| 1.4 DELL SUPPORT UTILITY | 17 |
| 1.4.1 Clicking the Dell Support Icon | 18 |
| 1.4.2 Double-Clicking the Dell Support Icon | 18 |
| 2 WORKING ON YOUR COMPUTER | 18 |
| 2.1 RECOMMENDED TOOLS | 18 |
| 2.2 BEFORE WORKING ON YOUR COMPUTER | 18 |
| 2.3 AFTER WORKING ON YOUR COMPUTER | 20 |
| 3 SCREW CHART | 21 |
| 4 BOTTOM ACCESS PANEL | 22 |
| 4.1 REMOVING THE BOTTOM ACCESS PANEL | 22 |
| 4.2 REPLACING THE BOTTOM ACCESS PANEL | 23 |
| 5 WLAN/WIMAX CARD | 23 |
| 5.1 REMOVING THE WLAN/WIMAX CARD | 24 |
| 5.2 REPLACING THE WLAN/WIMAX CARD | 24 |
| 6 WWAN CARD | 25 |
| 6.1 REMOVING A WWAN CARD | 25 |
| 6.2 REPLACING A WWAN CARD | 26 |
| 7 WPAN (UWB/BT) CARD | 26 |
| 7.1 REMOVING A WPAN (UWB/BT) CARD | 26 |
| 7.2 REPLACING A WPAN (UWB/BT) CARD | 27 |
| 8 FCM | 28 |
| 8.1 REMOVING A FCM FROM THE WWAN/FCM SLOT | 28 |
| 8.2 REMOVING A FCM FROM THE WPAN/UWB/FCM SLOT | 28 |
| 8.3 REPLACING A FCM | 29 |
| 9 RF PASSTHRU BOARD | 30 |
| 9.1 REMOVING THE RF PASSTHRU BOARD | 30 |

| | | |
|-----------|---|-----------|
| 9.2 | REPLACING THE RF PASSTHRU BOARD | 30 |
| 10 | FAN ASSEMBLY | 31 |
| 10.1 | REMOVING THE FAN ASSEMBLY | 31 |
| 10.2 | REPLACING THE FAN ASSEMBLY | 32 |
| 11 | PROCESSOR HEATSINK ASSEMBLY..... | 32 |
| 11.1 | REMOVING THE PROCESSOR HEATSINK ASSEMBLY | 32 |
| 11.2 | REPLACING THE PROCESSOR HEATSINK ASSEMBLY | 33 |
| 12 | PROCESSOR MODULE..... | 33 |
| 12.1 | REMOVING THE PROCESSOR MODULE..... | 33 |
| 12.2 | REPLACING THE PROCESSOR MODULE..... | 34 |
| 13 | MEMORY..... | 35 |
| 13.1 | REMOVING A MEMORY MODULE | 36 |
| 13.2 | REPLACING A MEMORY MODULE..... | 36 |
| 14 | COIN-CELL BATTERY | 37 |
| 14.1 | REMOVING THE COIN-CELL BATTERY | 37 |
| 14.2 | REPLACING THE COIN-CELL BATTERY..... | 37 |
| 15 | LED COVER..... | 38 |
| 15.1 | REMOVING THE LED COVER..... | 38 |
| 15.2 | REPLACING THE LED COVER | 39 |
| 16 | PALM REST OVERLAY | 39 |
| 16.1 | REMOVING THE PALM REST OVERLAY | 39 |
| 16.2 | REPLACING THE PALM REST OVERLAY | 40 |
| 17 | KEYBOARD | 40 |
| 17.1 | REMOVING THE KEYBOARD | 40 |
| 17.2 | REPLACING THE KEYBOARD..... | 41 |
| 18 | GPS CARD (OPTIONAL) | 41 |
| 18.1 | REMOVING THE GPS CARD..... | 41 |
| 18.2 | REPLACING THE GPS CARD..... | 42 |
| 19 | LCD CABLE CHANNEL COVERS | 42 |
| 19.1 | REMOVING THE LCD CABLE CHANNEL COVERS..... | 43 |
| 19.2 | REPLACING THE LCD CABLE CHANNEL COVERS..... | 43 |
| 20 | DISPLAY ASSEMBLY | 43 |
| 20.1 | REMOVING THE DISPLAY ASSEMBLY | 43 |
| 20.2 | REPLACING THE DISPLAY ASSEMBLY..... | 45 |
| 21 | PALM REST | 46 |
| 21.1 | REMOVING THE PALM REST | 46 |
| 21.2 | REPLACING THE PALM REST..... | 48 |
| 22 | MODEM | 48 |
| 22.1 | REMOVING THE MODEM..... | 48 |
| 22.2 | REPLACING THE MODEM..... | 49 |

| | |
|--|-----------|
| 23 SMARTCARD ASSEMBLY | 49 |
| 23.1 REMOVING THE SMARTCARD ASSEMBLY | 49 |
| 23.2 REPLACING THE SMARTCARD ASSEMBLY | 50 |
| 24 HARD DRIVE | 50 |
| 24.1 REMOVING THE HARD DRIVE..... | 51 |
| 24.2 REPLACING THE HARD DRIVE | 51 |
| 25 MODULAR DRIVE | 52 |
| 25.1 REMOVING THE MODULAR DRIVE..... | 52 |
| 25.2 REPLACING THE MODULAR DRIVE | 52 |
| 26 SYSTEM BOARD ASSEMBLY | 53 |
| 26.1 REMOVING THE SYSTEM BOARD ASSEMBLY | 53 |
| 26.2 REPLACING THE SYSTEM BOARD ASSEMBLY | 54 |
| 27 CARD CAGE | 55 |
| 27.1 REMOVING THE CARD CAGE | 55 |
| 27.2 REPLACING THE CARD CAGE..... | 56 |
| 28 1394 CARD | 56 |
| 28.1 REMOVING THE 1394 CARD..... | 57 |
| 28.2 REPLACING THE 1394 CARD..... | 57 |
| 29 SIM CARD | 57 |
| 29.1 REMOVING THE SIM CARD ASSEMBLY | 57 |
| 29.2 REPLACING THE SIM CARD ASSEMBLY..... | 58 |
| 30 WI-FI SNIFFER CARD | 58 |
| 30.1 REMOVING THE WI-FI SNIFFER CARD..... | 58 |
| 30.2 REPLACING THE WI-FI SNIFFER CARD..... | 59 |
| 31 I/O CARD | 59 |
| 31.1 REMOVING THE I/O CARD | 60 |
| 31.2 REPLACING THE I/O CARD | 60 |
| 32 RJ-11 MODEM CONNECTOR | 60 |
| 32.1 REMOVING THE RJ-11 MODEM CONNECTOR..... | 60 |
| 32.2 REPLACING THE RJ-11 MODEM CONNECTOR | 60 |
| 33 DC POWER CABLE | 61 |
| 33.1 REMOVING THE DC POWER CABLE | 61 |
| 33.2 REPLACING THE DC POWER CABLE..... | 62 |
| 34 BASE ASSEMBLY | 62 |
| 34.1 REMOVING THE BASE ASSEMBLY..... | 62 |
| 34.2 REPLACING THE BASE ASSEMBLY | 62 |
| 35 STYLUS | 62 |
| 35.1 REMOVING THE STYLUS..... | 62 |
| 35.2 REPLACING THE STYLUS..... | 63 |
| 36 HANDLE | 63 |

| | | |
|-----------|------------------------------------|-----------|
| 36.1 | REMOVING THE HANDLE..... | 63 |
| 36.2 | REPLACING THE HANDLE..... | 64 |
| 37 | DOORS | 64 |
| 37.1 | REMOVING MEDIA BAY DOOR | 64 |
| 37.2 | REPLACING MEDIA BAY DOOR..... | 65 |
| 37.3 | REMOVING THE AV DOOR..... | 65 |
| 37.4 | REPLACING THE AV DOOR | 66 |
| 37.5 | REMOVING THE AV PANEL COVER | 66 |
| 37.6 | REPLACING THE AV PANEL COVER..... | 66 |
| 37.7 | REMOVING THE RJ11 DOOR..... | 67 |
| 37.8 | REPLACING THE RJ11 DOOR..... | 67 |
| 37.9 | REMOVING THE BATTERY DOOR | 68 |
| 37.10 | REPLACING THE BATTERY DOOR | 68 |
| 37.11 | REMOVING THE POWER DOOR..... | 68 |
| 37.12 | REPLACING THE POWER DOOR | 69 |
| 37.13 | REMOVING THE VGA DOOR..... | 69 |
| 37.14 | REPLACING THE VGA DOOR..... | 70 |
| 37.15 | REMOVING THE VGA PANEL COVER | 70 |
| 37.16 | REPLACING THE VGA PANEL COVER..... | 71 |
| 37.17 | REMOVING THE HDD DOOR | 71 |
| 37.18 | REPLACING THE HDD DOOR | 71 |
| 37.19 | REMOVING THE SD CARD DOOR..... | 72 |
| 37.20 | REPLACING THE SD CARD DOOR..... | 72 |

1 Troubleshooting

1.1 Troubleshooting Tools



1.1.1 Diagnostic Lights



⚠ CAUTION: Before you begin any of the procedures in this section, follow the safety instructions that shipped with your computer.







Your computer has three keyboard status lights located above the keyboard. During normal operation, the keyboard status lights display the current status (*on* or *off*) of the Num Lock, Caps Lock, and Scroll Lock features. If the computer starts without error, the lights flash, and then turn off. If the computer malfunctions, however, you can use the status of the lights to help identify the problem.

📝 NOTE: After the computer completes POST, the Num Lock light may remain on, depending on your BIOS settings. For more information on using the system setup program, see the *Dell™ Technology Guide* on your computer or at support.dell.com.

Diagnostic Light Codes During POST

To troubleshoot a problem with your computer, read the sequence of the keyboard status lights in order from left to right (Num Lock, Caps Lock, and then Scroll Lock). If the computer malfunctions, the individual lights display a status of either *On* , *Off* , or *Flashing* .

| Light Pattern | Problem Description | Suggested Resolution |
|---|---|---|
|  | No memory Modules are detected | If two or more memory modules are installed, remove the modules (see Removing a Memory Module), then reinstall one module (see Replacing a Memory Module) and restart the computer. If the computer starts normally, continue to install additional memory modules (one at a time) until you have identified a faulty module or reinstalled all modules without error. If available, install working memory of the same type into your computer (see Memory). If the problem persists, contact Dell Support. |
|  | Memory modules are detected, but a memory failure has occurred. | If two or more memory modules are installed, remove the modules (see Removing a Memory Module), then reinstall one module (see Replacing a Memory Module) and restart the computer. If the computer starts normally continue to install additional memory modules (one at a time) until you have identified a faulty module or reinstalled all modules without error. If available, install working memory of the same type into your computer (see Memory). If the problem persists, contact Dell Support. |
|  | Memory failed to initialize or memory is unsupported. | If two or more memory modules are installed, remove the modules (see Removing a Memory Module), then reinstall one module (see Replacing a Memory Module) and restart the computer. If the computer starts normally, continue to install additional memory modules (one at a time) until you have identified a faulty module or reinstalled all modules without error. If available, install working memory of the same type into your computer (see Memory). If the problem persists, contact Dell Support. |

| | | |
|---|--|---|
|  | System board failure has occurred. | Contact Dell Support. |
|  | A possible processor failure has occurred. | Reseat the processor (see Processor Module). If the problem persists, contact Dell Support. |
|  | A possible graphics card/video failure has occurred. | Reseat any installed graphics cards. If available, install a working graphics card into your computer. If the problem persists, contact Dell Support. |
|  | A possible LCD failure has occurred. | Reseat the LCD cable (see Display Assembly). If the problem persists, contact Dell Support. |
|  | System failed on hard drive initialization. | Reseat the hard drive (see Hard Drive). If the problem persists, contact Dell Support. |
|  | System failed in Option ROM initialization. | If you have added any plug-in hardware with an option ROM, try removing or reseating it. If the problem persists, contact Dell Support. |
|  | A possible modem failure has occurred. | If available, install a working modem into your computer. If the problem persists, contact Dell Support. |

1.1.2 Hardware Troubleshooter

If a device is either not detected during the operating system setup or is detected, but incorrectly configured, you can use the Hardware Troubleshooter to resolve the incompatibility.

Microsoft® Windows® XP:

1. Click **Start**→ **Help and Support**.
2. Type hardware troubleshooter in the search field and press <Enter> to start the search.
3. In the **Fix a Problem** section, click **Hardware Troubleshooter**.
4. In the **Hardware Troubleshooter** list, select the option that best describes the problem and click **Next** to follow the remaining troubleshooting steps.

Microsoft Windows Vista®:

1. Click the Windows Vista start button , and click **Help and Support**.
2. Type hardware troubleshooter in the search field and press <Enter> to start the search.
3. In the search results, select the option that best describes the problem and follow the remaining troubleshooting steps.

1.1.3 Dell Diagnostics

 **CAUTION:** Before you begin any of the procedures in this section, follow the safety instructions that shipped with your computer.

When to Use the Dell Diagnostics

If you experience a problem with your computer, perform the checks in [Solving Problems](#), and then run the Dell Diagnostics before contacting Dell for assistance.

Start the Dell Diagnostics from your hard drive or from the *Drivers and Utilities* media provided with your computer.

 **NOTE:** The *Drivers and Utilities* media is optional and may not ship with your computer.

 **NOTE:** The Dell Diagnostics only operate on Dell computers.

Starting the Dell Diagnostics From Your Hard Drive

Before running the Dell Diagnostics, enter system setup to review your computer's configuration information, and ensure that the device you want to test is displayed in system setup and is active. For more information on using the system setup program, see the *Dell™ Technology Guide* on your computer or at support.dell.com.

The Dell Diagnostics is located on a separate diagnostic utility partition on your hard drive.

 **NOTE:** If the computer is connected to a docking device (docked), undock it. See the documentation that came with your docking device for instructions.

 **NOTE:** If your computer does not display a screen image, contact Dell Support.

1. Ensure that the computer is connected to an electrical outlet that is known to be working properly.
2. Press and hold the <Fn> key or the mute button then turn on your computer.

 **NOTE:** Alternatively, you can select **Diagnostics** from the one-time boot menu at startup to boot to the diagnostic utility partition and run the Dell Diagnostics.

The computer runs the Pre-boot System Assessment (PSA), a series of initial tests of your system board, keyboard, display, memory, hard drive, etc.

- During the assessment, answer any questions that appear.
- If failures are detected during the Pre-boot System Assessment, write down the error code(s) and contact Dell Support.
- If the Pre-boot System Assessment completes successfully, the following message appears: "Booting Dell Diagnostic Utility Partition. Press any key to continue."

 **NOTE:** If you see a message stating that no diagnostics utility partition has been found, run the Dell Diagnostics from your *Drivers and Utilities* media (see [Starting the Dell Diagnostics From the Drivers and Utilities Media](#)).

3. Press any key to start the Dell Diagnostics from the diagnostics utility partition on your hard drive.
4. Press <Tab> to select **Test System** and then press <Enter>.

 **NOTE:** It is recommended that you select **Test System** to run a complete test on your computer. Selecting **Test Memory** initiates the extended memory test which can take up to thirty minutes or more to complete. When the test completes, record the test results and then press any key to return to the previous menu.

5. At the Dell Diagnostics Main Menu, left-click with the touch pad/mouse, or press <Tab> and then <Enter>, to select the test you want to run (see [Dell Diagnostics Main Menu](#)).

 **NOTE:** Write down any error codes and problem descriptions exactly as they appear and follow the instructions on the screen.

6. After all tests have completed, close the test window to return to the Dell Diagnostics Main Menu.
7. Close the Main Menu window to exit the Dell Diagnostics and restart the computer.

 **NOTE:** If you see a message stating that no diagnostics utility partition has been found, run the Dell Diagnostics from your *Drivers and Utilities* media (see [Starting the Dell Diagnostics From the Drivers and Utilities Media](#)).

Starting the Dell Diagnostics From the Drivers and Utilities Media

Before running the Dell Diagnostics, enter system setup to review your computer's configuration information, and ensure that the device you want to test is displayed in system setup and is active. For more information on using the system setup program, see the *Dell™ Technology Guide* on your computer or at support.dell.com.

1. Insert the *Drivers and Utilities* media into the optical drive.
2. Restart your computer.
3. When the DELL logo appears, press <F12> immediately.

 **NOTE:** Keyboard failure may result when a key is held down for extended periods of time. To avoid possible keyboard failure, press and release <F12> in even intervals to open the Boot Device Menu.

If you wait too long and the operating system logo appears, continue to wait until you see the Microsoft Windows desktop, then shut down your computer and try again.

4. When the boot device list appears, use the up- and down-arrow keys to highlight **CD/DVD/CD-RW Drive**, and then press <Enter>.

 **NOTE:** Using the one-time boot menu changes the boot sequence for the current boot only. Upon restart, the computer boots according to the boot sequence specified in system setup.

5. Press any key to confirm that you want to start from the CD/DVD
If you wait too long and the operating system logo appears, continue to wait until you see the Microsoft Windows desktop, then shut down your computer and try again.
6. Type 1 to **Run the 32 Bit Dell Diagnostics**.
7. At the Dell Diagnostics Menu, type 1 to select **Dell 32-bit Diagnostics for Resource CD (graphical user interface)**.
8. Press <Tab> to select **Test System** and the press <Enter>.

 **NOTE:** It is recommended that you select **Test System** to run a complete test on your computer. Selecting **Test Memory** initiates the extended memory test which can take up to thirty minutes or more to complete. When the test completes, record the test results and then press any key to return to the previous menu.

9. At the Dell Diagnostics Main Menu, left-click with the touch pad/mouse, or press <Tab> and then <Enter>, to select the test you want to run (see [Dell Diagnostics Main Menu](#)).

 **NOTE:** Write down any error codes and problem descriptions exactly as they appear and follow the instructions on the screen.

10. After all tests have completed, close the test window to return to the Dell Diagnostics Main Menu.
11. Close the Main Menu window to exit the Dell Diagnostics and restart the computer.
12. Remove the *Drivers and Utilities* media from the optical drive.

Dell Diagnostics Main Menu

After the Dell Diagnostics loads, the following menu appears:

| Option | Function |
|-------------|---------------------------------|
| Test Memory | Run the stand-alone memory test |
| Test System | Run system diagnostics |
| Exit | Exit the diagnostics |

Press <Tab> to select the test you want to run and then press <Enter>.

 **NOTE:** It is recommended that you select **Test System** to run a complete test on your computer. Selecting **Test Memory** initiates the extended memory test which can take up to

thirty minutes or more to complete. When the test completes, record the test results and then press any key to return to the previous menu.

After **Test System** is selected, the following menu appears:

| Option | Function |
|--------------|---|
| Express Test | Performs a quick test of devices in the system. This typically can take 10 to 20 minutes. NOTE: The Express Test requires no interaction on your part. Run Express Test first to increase the possibility of tracing a problem quickly. |
| Custom Test | Use to test a specific device or customize the tests to be run. |
| Symptom Tree | This option allows you to select tests based on a symptom of the problem you are having. This option lists the most common symptoms. |

 **NOTE:** It is recommended that you select **Extended Test** to perform a more thorough check of devices in the computer.

For any problem encountered during a test, a message appears with an error code and a description of the problem. Write down the error code and problem description exactly as it appears and follow the instructions on the screen. If you cannot resolve the problem, contact Dell Support.

 **NOTE:** When contacting Dell Support, have your Service Tag ready. The Service Tag for your computer is located at the top of each test screen.

The following tabs provide additional information for tests run from the Custom Test or Symptom Tree option:

| Tab | Function |
|---------------|--|
| Results | Displays the results of the test and any error conditions encountered. |
| Errors | Displays error conditions encountered, error codes, and the problem description. |
| Help | Describes the test and any requirements for running the test. |
| Configuration | Displays the hardware configuration for the selected device. The Dell Diagnostics obtains configuration information for all devices from System Setup, memory, and various internal tests, and displays the information in the device list in the left pane of the screen. NOTE: The device list may not display the names of all components installed on your computer or all devices attached to your computer. |
| Parameters | Allows you to customize the test, if applicable, by changing the test settings. |

1.1.4 Error Messages

 **CAUTION:** Before you begin any of the procedures in this section, follow the safety instructions that shipped with your computer.

If the error message is not listed, see the documentation for the operating system or the program that was running when the message appeared.

A FILENAME CANNOT CONTAIN ANY OF THE FOLLOWING CHARACTERS: \ / : * ? " < > | — Do not use these characters in filenames.

A REQUIRED .DLL FILE WAS NOT FOUND — The program that you are trying to open is missing an essential file. To remove and then reinstall the program:

Windows XP:

1. Click **Start** → **Control Panel** → **Add or Remove Programs** → **Programs and Features**.
2. Select the program you want to remove.
3. Click **Uninstall**.
4. See the program documentation for installation instructions.

Windows Vista:

1. Click **Start**  → **Control Panel** → **Programs** → **Programs and Features**.
2. Select the program you want to remove.
3. Click **Uninstall**.
4. See the program documentation for installation instructions.

drive letter : \ IS NOT ACCESSIBLE. THE DEVICE IS NOT READY — The drive cannot read the disk. Insert a disk into the drive and try again.

INSERT BOOTABLE MEDIA — Insert a bootable floppy disk, CD, or DVD.

NON-SYSTEM DISK ERROR — Remove the floppy disk from the floppy drive and restart your computer.

NOT ENOUGH MEMORY OR RESOURCES. CLOSE SOME PROGRAMS AND TRY

AGAIN — Close all windows and open the program that you want to use. In some cases, you may have to restart your computer to restore computer resources. If so, run the program that you want to use first.

OPERATING SYSTEM NOT FOUND — Contact Dell Support.

1.2 Solving Problems

 **CAUTION:** Before you begin any of the procedures in this section, follow the safety instructions that shipped with your computer.

Follow these tips when troubleshooting your computer:

- If you added or removed a part before the problem started, review the installation procedures and ensure that the part is correctly installed.
- If a peripheral device does not work, ensure that the device is properly connected.
- If an error message appears on the screen, write down the exact message. This message may help support personnel diagnose and fix the problem(s).
- If an error message occurs in a program, see the program's documentation.

 **NOTE:** The procedures in this document were written for the Windows default view, so they may not apply if you set your Dell computer to the Windows Classic view.

1.2.1 Battery Problems

-  **CAUTION:** There is a danger of a new battery exploding if it is incorrectly installed. Replace the battery only with the same or equivalent type recommended by the manufacturer. Discard used batteries according to the manufacturer's instructions.

1.2.2 Drive Problems

-  **CAUTION:** Before you begin any of the procedures in this section, follow the safety instructions that shipped with your computer.

ENSURE THAT MICROSOFT WINDOWS RECOGNIZES THE DRIVE —

Windows XP:

- Click **Start** and click **My Computer**.

Windows Vista:

- Click the Windows Vista Start button  and click **Computer**.

If the drive is not listed, perform a full scan with your antivirus software to check for and remove viruses. Viruses can sometimes prevent Windows from recognizing the drive.

TEST THE DRIVE —

- Insert another disc to eliminate the possibility that the original drive is defective.
- Insert a bootable floppy disk and restart the computer.

CLEAN THE DRIVE OR DISK — For information on cleaning your computer, see the *Dell™ Technology Guide* on your computer or at support.dell.com.

CHECK THE CABLE CONNECTIONS

RUN THE HARDWARE TROUBLESHOOTER — See [Hardware Troubleshooter](#).

RUN THE DELL DIAGNOSTICS — See [Dell Diagnostics](#).

Optical Drive Problems

 **NOTE:** High-speed optical drive vibration is normal and may cause noise, which does not indicate a defect in the drive or the media.

 **NOTE:** Because of different regions worldwide and different disc formats, not all DVD titles work in all DVD drives.

ADJUST THE WINDOWS VOLUME CONTROL —

- Click the speaker icon in the lower-right corner of your screen.
- Ensure that the volume is turned up by clicking the slider and dragging it up.
- Ensure that the sound is not muted by clicking any boxes that are checked.

CHECK THE SPEAKERS AND SUBWOOFER — See [Sound and Speaker Problems](#).

Problems writing to an optical drive

CLOSE OTHER PROGRAMS — The optical drive must receive a steady stream of data during the writing process. If the stream is interrupted, an error occurs. Try closing all programs before you write to the optical.

TURN OFF STANDBY MODE IN WINDOWS BEFORE WRITING TO A DISC — For information about setting power options, see the *Dell™ Technology Guide* on your computer or at support.dell.com. You can also search for the keyword *standby* in Windows Help and Support for information on power management modes.

Hard Drive Problems

RUN CHECK DISK —

Windows XP:

1. Click **Start and click My Computer**.
2. Right-click **Local Disk C:**.
3. Click **Properties**→ **Tools**→ **Check Now**.
4. Click **Scan for and attempt recovery of bad sectors and click Start**.

Windows Vista:

1. Click **Start**  and click **Computer**.
2. Right-click **Local Disk C:**.
3. Click **Properties**→ **Tools**→ **Check Now**.
The **User Account Control** window may appear. If you are an administrator on the computer, click **Continue**; otherwise, contact your administrator to continue the desired action.
4. Follow the instructions on the screen.

1.2.3 IEEE 1394 Device Problems

 **CAUTION:** Before you begin any of the procedures in this section, follow the safety instructions that shipped with your computer.

 **NOTE:** Your computer supports only IEEE 1394a standard.

ENSURE THAT THE CABLE FOR THE IEEE 1394 DEVICE IS PROPERLY INSERTED INTO THE DEVICE AND INTO THE CONNECTOR ON THE COMPUTER

ENSURE THAT THE IEEE 1394 DEVICE IS ENABLED IN SYSTEM SETUP — For more information on using the system setup program, see the *Dell™ Technology Guide* on your computer or at support.dell.com.

ENSURE THAT THE IEEE 1394 DEVICE IS RECOGNIZED BY WINDOWS —

Windows XP:

5. Click **Start and click Control Panel**.
6. Under **Pick a Category**, click **Performance and Maintenance**→ **System**→ **System Properties** → **Hardware**→ **Device Manager**.

Windows Vista:

Click **Start**  → **Control Panel**→ **Hardware and Sound**.
Click **Device Manager**. If your IEEE 1394 device is listed, Windows recognizes the device.

IF YOU HAVE PROBLEMS WITH A DELL IEEE 1394 DEVICE — Contact Dell Support.

IF YOU HAVE PROBLEMS WITH AN IEEE 1394 DEVICE NOT PROVIDED BY DELL — Contact the IEEE 1394 device manufacturer.

1.2.4 Lockups and Software Problems

 **CAUTION:** Before you begin any of the procedures in this section, follow the safety instructions that shipped with your computer.

The Computer Does Not Start Up

CHECK THE DIAGNOSTIC LIGHTS — See [Power Problems](#).

ENSURE THAT THE POWER CABLE IS FIRMLY CONNECTED TO THE COMPUTER AND TO THE ELECTRICAL OUTLET

The computer stops responding

 **NOTICE:** You may lose data if you are unable to perform an operating system shutdown.

TURN THE COMPUTER OFF — If you are unable to get a response by pressing a key on your keyboard or moving your mouse, press and hold the power button for at least 8 to 10 seconds (until the computer turns off), and then restart your computer.

A Program Stops Responding

END THE PROGRAM —

1. Press <Ctrl><Shift><Esc> simultaneously to access the Task Manager.
2. Click the **Applications** tab.
3. Click to select the program that is no longer responding.
4. Click **End Task**.

A Program Crashes Repeatedly

 **NOTE:** Most software includes installation instructions in its documentation or on a floppy disk, CD, or DVD.

CHECK THE SOFTWARE DOCUMENTATION — If necessary, uninstall and then reinstall the program.

A Program is Designed for an Earlier Windows Operating System

RUN THE PROGRAM COMPATIBILITY WIZARD —

Windows XP:

The Program Compatibility Wizard configures a program so that it runs in an environment similar to non-XP operating system environments.

1. Click **Start** → **All Programs** → **Accessories** → **Program Compatibility Wizard** → **Next**.
2. Follow the instructions on the screen.

Windows Vista:

The Program Compatibility Wizard configures a program so that it runs in an environment similar to non-Windows Vista operating system environments.

1. Click **Start**  → **Control Panel** → **Programs** → **Use an older program with this version of Windows**.
2. In the welcome screen, click **Next**.
3. Follow the instructions on the screen.

A Solid Blue Screen Appears

TURN THE COMPUTER OFF — If you are unable to get a response by pressing a key on your keyboard or moving your mouse, press and hold the power button for at least 8 to 10 seconds (until the computer turns off), and then restart your computer.

Other Software Problems

CHECK THE SOFTWARE DOCUMENTATION OR CONTACT THE SOFTWARE MANUFACTURER FOR TROUBLESHOOTING INFORMATION —

- Ensure that the program is compatible with the operating system installed on your computer.
- Ensure that your computer meets the minimum hardware requirements needed to run the software. See the software documentation for information.
- Ensure that the program is installed and configured properly.
- Verify that the device drivers do not conflict with the program.
- If necessary, uninstall and then reinstall the program.

BACK UP YOUR FILES IMMEDIATELY

USE A VIRUS-SCANNING PROGRAM TO CHECK THE HARD DRIVE, FLOPPY DISKS, CDS, OR DVDS

SAVE AND CLOSE ANY OPEN FILES OR PROGRAMS AND SHUT DOWN YOUR COMPUTER THROUGH THE START MENU

1.2.5 Memory Problems

 **CAUTION:** Before you begin any of the procedures in this section, follow the safety instructions that shipped with your computer.

IF YOU RECEIVE AN INSUFFICIENT MEMORY MESSAGE —

Save and close any open files and exit any open programs you are not using to see if that resolves the problem.

- See the software documentation for minimum memory requirements. If necessary, install additional memory (see [Replacing a Memory Module](#)).
- Reseat the memory modules (see [Memory](#)) to ensure that your computer is successfully communicating with the memory.
- Run the Dell Diagnostics (see [Dell Diagnostics](#)).

IF YOU EXPERIENCE OTHER MEMORY PROBLEMS —

- Reseat the memory modules (see [Memory](#)) to ensure that your computer is successfully communicating with the memory.
- Ensure that you are following the memory installation guidelines (see [Replacing a Memory Module](#)).
- Ensure that the memory you are using is supported by your computer. For more information about the type of memory supported by your computer, see the *Setup and Features Information Guide* for your computer at support.dell.com.
- Run the Dell Diagnostics (see [Dell Diagnostics](#)).

1.2.6 Power Problems

 **CAUTION:** Before you begin any of the procedures in this section, follow the safety instructions that shipped with your computer.

IF THE POWER LIGHT IS BLUE AND THE COMPUTER IS NOT RESPONDING — See [Diagnostic Lights](#).

IF THE POWER LIGHT IS OFF — The computer is either turned off or is not receiving power.

- Reseat the power cable in the power connector on the back of the computer and the electrical outlet.
- Bypass power strips, power extension cables, and other power protection devices to verify that the computer turns on properly.
- Ensure that any power strips being used are plugged into an electrical outlet and are turned on.
- Ensure that the electrical outlet is working by testing it with another device, such as a lamp.

ELIMINATE INTERFERENCE — Some possible causes of interference are:

- Power, keyboard, and mouse extension cables
- Too many devices connected to the same power strip
- Multiple power strips connected to the same electrical outlet

1.2.7 Sound and Speaker Problems

 **CAUTION:** Before you begin any of the procedures in this section, follow the safety instructions that shipped with your computer.

 **NOTE:** The volume control in MP3 and other media players may override the Windows volume setting. Always check to ensure that the volume on the media player(s) has not been turned down or off.

ADJUST THE WINDOWS VOLUME CONTROL — Click or double-click the speaker icon in the lower-right corner of your screen. Ensure that the volume is turned up and that the sound is not muted.

DISCONNECT HEADPHONES FROM THE HEADPHONE CONNECTOR — Sound from the speakers is automatically disabled when headphones are connected to the computer's front-panel headphone connector.

ELIMINATE POSSIBLE INTERFERENCE — Turn off nearby fans, fluorescent lights, or halogen lamps to check for interference.

RUN THE HARDWARE TROUBLESHOOTER — See [Hardware Troubleshooter](#).

No Sound From Headphones

CHECK THE HEADPHONE CABLE CONNECTION — Ensure that the headphone cable is securely inserted into the headphone connector. See the *Setup and Features Information Guide* for your computer at support.dell.com.

ADJUST THE WINDOWS VOLUME CONTROL — Click or double-click the speaker icon in the lower-right corner of your screen. Ensure that the volume is turned up and that the sound is not muted.

1.2.8 Video and Display Problems

 **CAUTION:** Before you begin any of the procedures in this section, follow the safety instructions that shipped with your computer.

 **NOTICE:** If your computer came with a PCI graphics card installed, removal of the card is not necessary when installing additional graphics cards; however, the card is required for troubleshooting purposes. If you remove the card, store it in a safe and secure location. For information about your graphics card, go to support.dell.com.

CHECK THE DIAGNOSTIC LIGHTS — See [Diagnostic Lights](#).

CHECK THE DISPLAY SETTINGS — See the *Dell™ Technology Guide* on your computer or at support.dell.com.

ADJUST THE WINDOWS DISPLAY SETTINGS —

Windows XP:

1. Click **Start** → **Control Panel** → **Appearance and Themes**.
2. Click the area you want to change or click the **Display** icon.
3. Try different settings for **Color quality** and **Screen resolution**.

Windows Vista:

1. Click **Start**  → **Control Panel** → **Hardware and Sound** → **Personalization** → **Display Settings**.
2. Adjust **Resolution** and **Colors settings**, as needed.

Only Part of the Display is Readable

CONNECT AN EXTERNAL MONITOR —

1. Shut down your computer and connect an external monitor to the computer.
2. Turn on the computer and the monitor and adjust the monitor brightness and contrast controls.

If the external monitor works, the computer display or video controller may be defective. Contact Dell Support.

1.3 Dell Technical Update Service

The Dell Technical Update service provides proactive e-mail notification of software and hardware updates for your computer. The service is free and can be customized for content, format, and how frequently you receive notifications.

To enroll for the Dell Technical Update service, go to support.dell.com.

1.4 Dell Support Utility

The Dell Support Utility is installed on your computer and available from the Dell Support, , icon on the taskbar or from the **Start** button. Use this support utility for self-support information, software updates, and health scans of your computing environment.

Accessing the Dell Support Utility

Access the Dell Support Utility from the  icon on the taskbar or from the **Start** menu.

If the Dell Support icon does not appear in your taskbar:

1. Click **Start**→ **All Programs**→ **Dell Support**→ **Dell Support Settings**.
2. Ensure that the **Show icon on the taskbar** option is checked.

 **NOTE:** If the Dell Support Utility is not available from the Start menu, go to support.dell.com and download the software.

The Dell Support Utility is customized for your computing environment. The  icon in the taskbar functions differently when you click, double-click, or right-click the icon.

1.4.1 Clicking the Dell Support Icon

Click or right-click the  icon to perform the following tasks:

- Check your computing environment.
- View the Dell Support Utility settings.
- Access the help file for the Dell Support Utility.
- View frequently asked questions.
- Learn more about the Dell Support Utility.
- Turn the Dell Support Utility off.

1.4.2 Double-Clicking the Dell Support Icon

Double-click the  icon to manually check your computing environment, view frequently asked questions, access the help file for the Dell Support Utility, and view Dell Support settings.

For more information about the Dell Support Utility, click the question mark (?) at the top of the **Dell™ Support** screen.

2 Working on Your Computer

This document provides procedures for removing and installing the components in your computer. Unless otherwise noted, each procedure assumes that the following:

- You have performed the steps in [Before Working On Your Computer](#).
- You have read the safety information that shipped with your computer.

 **NOTE:** The color of your system and certain system components may appear differently than shown in this document.

2.1 Recommended Tools





The procedures in this document may require the following tools:

- Small flat-blade screwdriver
- Phillips screwdriver
- Small plastic scribe
- 5-mm hex nut driver (for VGA posts)
- Flash BIOS update (see the Dell Support website at support.dell.com)

2.2 Before Working On Your Computer

Use the following safety guidelines to help protect your computer from potential damage and to help ensure your own personal safety.

 **CAUTION:** Before you begin any of the procedures in this section, follow the safety instructions that shipped with your computer.

- ➔ **NOTICE:** Only a certified service technician should perform repairs on your computer. Damage due to servicing that is not authorized by Dell is not covered by your warranty.
 - ➔ **NOTICE:** To avoid electrostatic discharge, ground yourself by using a wrist grounding strap or by periodically touching an unpainted metal surface, such as a connector on the back of the computer.
 - ➔ **NOTICE:** Handle components and cards with care. Do not touch the components or contacts on a card. Hold a card by its edges or by its metal mounting bracket. Hold a component such as a processor by its edges, not by its pins.
 - ➔ **NOTICE:** When disconnecting a cable, pull on the cable's connector or on its strain-relief loop, not on the cable itself. For cable connectors with locking tabs, press inward on the locking tabs to release the connector. When connecting a cable, ensure that the connectors are correctly oriented and aligned to avoid damage to the connector and/or the connector's pins.
1. Ensure that the work surface is flat and clean to prevent the computer cover from being scratched.
 2. Shut down your computer.
 - In Windows XP, click **Start**→ **Shutdown**→ **Shutdown**.
 - In Windows Vista, click **Start** , click the arrow  icon, and then click **Shut Down** to turn off your computer.
-  **NOTE:** Ensure that the computer is off and not in a power management mode. If you cannot shut down the computer using the operating system, press and hold the power button for 4 seconds.
3. Disconnect your computer and all attached devices from their electrical outlets.
- ➔ **NOTICE:** To disconnect a network cable, first unplug the cable from your computer and then unplug it from the network device.
4. Disconnect any telephone, network, and USB cables from the computer.
- ➔ **NOTICE:** To help prevent damage to the system board, you must remove the battery from the battery bay before you service the computer.
-  **NOTE:** See the battery removal instructions adhered to the edge of the battery.
5. Open the rear battery door by sliding the latch to the right and then downward.
 6. Turn the computer upside down.
 7. Slide the battery release latches toward each other to place them in the unlocked position.
 8. Open door fully and pull the battery tab to slide the battery out of the battery bay.



9. Disconnect any external devices and remove any installed cards before working on your computer:
 - To remove any installed cards, such as an ExpressCard Card, see the *Dell™ Technology Guide* on your computer or at **support.dell.com**.
 - To undock from a docking station, see the *E-Port User's Guide* or the *E-Port Plus User's Guide* on **support.dell.com**.
 - To remove the docking adapter, see the documentation that shipped with your E-Port Adapter or see the *E-Port Adapter Quick Setup Guide* on **support.dell.com**.
 - To remove a battery slice, see the documentation that shipped with your battery slice or on **support.dell.com**.
10. Turn the computer topside up, open the display, and press the power button to ground the system board.



2.3 After Working On Your Computer





After you have completed the replacement procedures, ensure you connect the external devices, cards, cables, etc. before turning on your computer.

 **NOTE:** To avoid damage to the computer, use only the battery designed for this particular Dell computer. Do not use batteries designed for other Dell computers.

1. Connect any external devices, such as a port replicator, or battery slice, and replace any cards, such as an ExpressCard.
2. Connect any telephone or network cables to your computer.
3. Replace the battery. Slide the battery into the battery bay until it clicks into place and close the battery door.
4. Connect your computer and all attached devices to their electrical outlets.
5. Turn on your computer.

3 Screw Chart

| S. no | Screw p/n | Screw Image | Used Assy p/n | Description | Qty/ Assy | Total Qty |
|-------|-----------|---|---------------|---|-----------|-----------|
| 1 | 21106-00 |  | | SCR,PHH,PNH,M2X3,STL, BLK OXD,NYLOK | | |
| | | | 21010-01 | ASSY,DOOR,BTRY,BLK,CYN | 7 | |
| | | | 21012-01 | ASSY,DOOR,HDD,BLK,CYN | 2 | |
| | | | 21014-01 | ASSY,DOOR,DVD,PCMCIA,BLK,CYN | 2 | |
| | | | 21001-01 | ASSY,DOORS,CHASSIS,BASE,BLK,CYN | 17 | |
| | | | 21000-03 | ASSY,CHASSIS,BASE,DSC,PRC,PCMCIA,BLK,CYN | 4 | 53 |
| | | | 21025-01 | ASSY,PALM REST,FPR,BLK,CYN | 4 | |
| | | | 21056 | ASSY,PCBA,FPR,2810,CYN | 3 | |
| | | | 21040-01 | ASSY,BZL,BTM,BLK,CYN ASSY,LCD,NON TOUCH, | 8 | |
| | | | 21902-03 | CMRA+MIC,BLK,CYN | 6 | |
| 2 | 21106-01 |  | | SCR,PHH,PNH,M2.5X5,STL,BLK OXD,NYLOK | | |
| | | | 21900-10 | BASE,DSC,PCMCIA,FPR,BLK,CYN | 4 | |
| | | | 21000-03 | ASSY,CHASSIS,BASE,DSC,PRC,PCMCIA,BLK,CYN | 13 | |
| | | | 21001-01 | ASSY,DOORS,CHASSIS,BASE,BLK,CYN | 4 | |
| | | | 21009-03 | ASSY,DOOR,HNG,LIVING,RJ11,BLK,CYN | 2 | |
| | | | 21055-01 | ASSY,DOOR,SD,BLK,CYN | 2 | 37 |
| | | | 21025-01 | ASSY,PALM REST,FPR,BLK,CYN | 2 | |
| | | | 21044-01 | SUBASSY, HEAT STAKE, PALM REST, FPR,BLK,CYN | 6 | |
| | | | 21040-01 | ASSY,BZL,BTM,BLK,CYN | 2 | |
| | | | 21009-01 | ASSY,DOOR,HNG,LIVING,PWR,BLK,CYN | 2 | |

| | | | | | | |
|---|----------|---|----------|--|----|----|
| 3 | 21106-02 |  | | SCR,PHH,PNH,M2.5X8,STL,BLK OXD,NYLOK | | |
| | | | 21900-10 | BASE,DSC,PCMCIA,FPR,BLK,CYN | 20 | |
| | | | 21000-03 | ASSY,CHASSIS,BASE,DSC, PRC, PCMCIA, BLK,CYN | 2 | |
| | | | 21030-01 | ASSY,HDL,BLK,CYN | 3 | 57 |
| | | | 21902-03 | ASSY,LCD,NON TOUCH, CMRA+MIC,BLK,CYN | 24 | |
| | | | 21051-01 | SUBASSY,LCD OUTER,BLK,CYN | 8 | |
| 4 | 21106-03 |  | | SCR,PHH,PNH,M3X3,STL, BLK OXD,NYLOK | | |
| | | | 21010-01 | ASSY,DOOR,BTRY,BLK,CYN | 8 | |
| | | | 21012-01 | ASSY,DOOR,HDD,BLK,CYN | 4 | |
| | | | 21014-01 | ASSY,DOOR,DVD,PCMCIA, BLK,CYN | 6 | 26 |
| | | | 21016-01 | ASSY,DOOR,AUDIO,BLK,CYN | 4 | |
| | | | 21018-01 | ASSY,DOOR,VGA,BLK,CYN | 4 | |
| 5 | 21399 |  | 40057 | SCR,CAPTIVE,PHH,PNH,M2.5X 9.85,STL,NKL PL | | |
| | | | | ASSY,GASKET,KEYBOARD, BRKT, CYN | 2 | 2 |
| 6 | 21381 |  | | SCR,THRM,STL | | |
| | | | 21034-00 | ASSY,HTSK,CU,GROM,CYN | 4 | 4 |

4 Bottom Access Panel

 **CAUTION:** Before you begin any of the procedures in this section, follow the safety instructions that shipped with your computer.

4.1 Removing the Bottom Access Panel

1. Follow the procedures in [Before Working on Your Computer](#).
2. Close the display and turn the computer upside down.
3. Remove the twenty-one M2.5 x 5-mm screws that secure the bottom access panel as indicated in the figure below.
4. Lift the bottom access panel to remove it from the base assembly.

NOTE: No snaps are used to attach the bottom access panel to the base. There is a gasket attached to the perimeter of the bottom access panel, and this gasket might provide some resistance during removal.

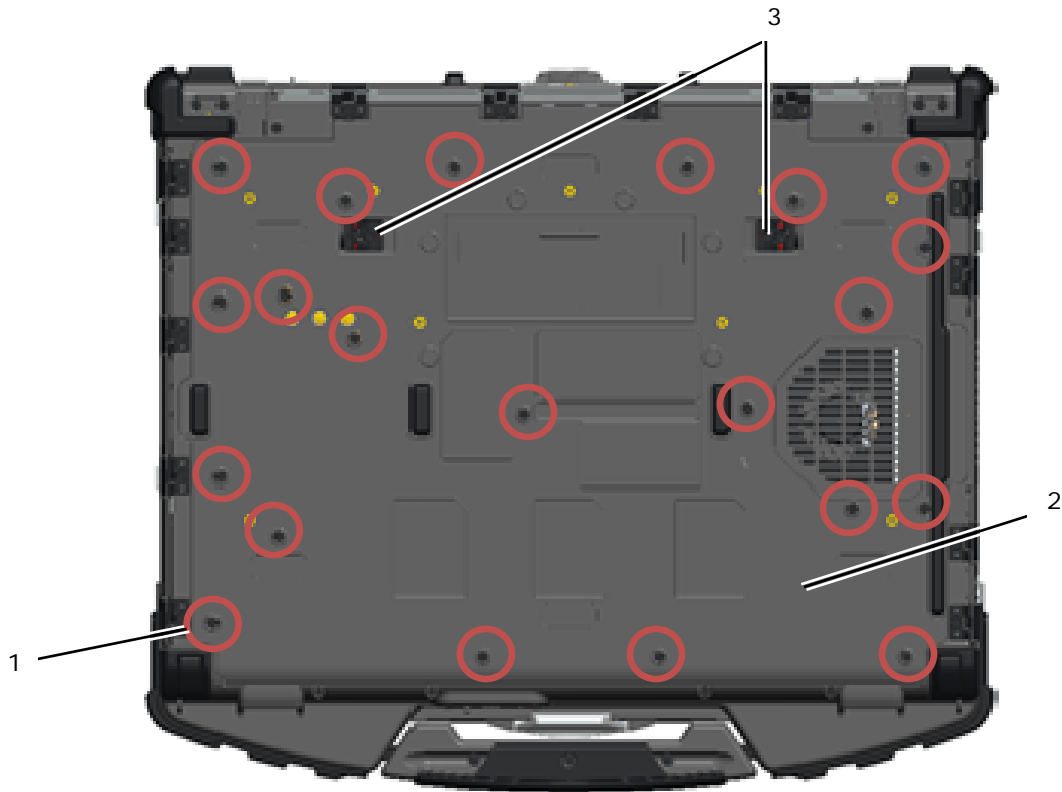

- 1 M2.5 x 5mm screws (21)
- 2 Bottom of computer
- 3 Battery release slider latches (2)

4.2 Replacing the Bottom Access Panel

1. Position the Bottom Access Panel into place.

NOTE: Ensure the battery release slider latches on the bottom access panel are in their locked positions. See photo below for correct slider latches positions.



Battery release latches in locked position

2. Replace and tighten the twenty-one M2.5 x 5-mm screws
3. Follow the procedures in [After Working on Your Computer](#).

5 WLAN/WiMax Card

CAUTION: Before you begin any of the procedures in this section, follow the safety instructions that shipped with your computer.

NOTICE: Insert a WLAN or WiMax card only into the slot labeled WLAN/WiMax.

5.1 Removing the WLAN/WiMax Card

1. Follow the procedures in [Before Working on Your Computer](#).
2. Remove the Bottom Access Panel (see [Removing the Bottom Access Panel](#)).
3. Disconnect the antenna cables from the card.
4. Remove the M2 x 3-mm screw. The card will pop up at a 45-degree angle.

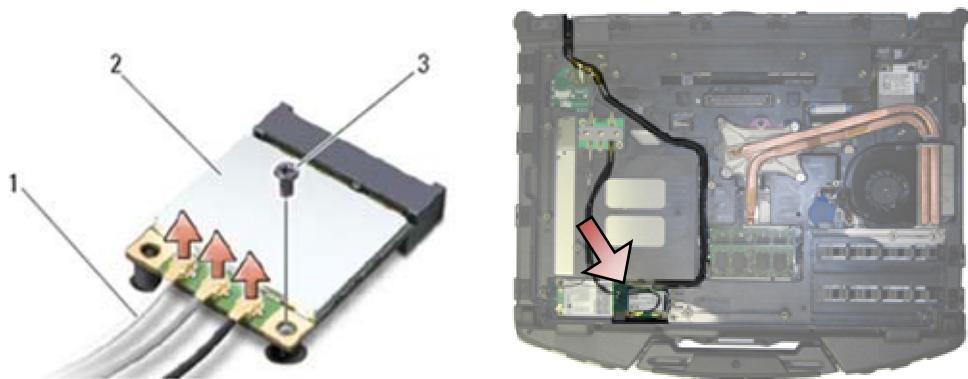

1 Antenna cables (3) 2 WLAN/WiMax card
3 M2 x 3-mm screw

5. Slide the card out of the card connector on the system board.

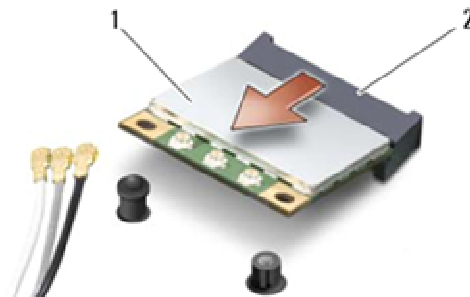

1 WLAN/WiMax card 2 Card connector

5.2 Replacing the WLAN/WiMax Card

➔ **NOTICE:** The connectors are keyed to ensure correct insertion. If you feel resistance, check the connectors on the card and on the system board, and realign the card.

➔ **NOTICE:** To avoid damage to the WLAN or WiMax card, ensure the cables are not under the card when you replace it.

➔ **NOTICE:** Insert a WLAN or WiMax card only into the slot labeled WLAN/WiMax.

1. Slide the card into the connector labeled WLAN/WiMax.
2. Press the card down and hold it in place.
3. Replace the M2 x 3-mm screw.
4. Connect the appropriate antenna cables to the card you are installing: If the card has two triangles on the label (white and black), connect the white antenna cable to the connector labeled "main" (white triangle), and connect the black antenna cable to the connector labeled "aux" (black triangle). Secure the gray antenna cable in the plastic holder next to the card.



- | | |
|-----------------------|-----------------------|
| 1 WLAN card | 2 Grey antenna cable |
| 3 Holder by card | 4 White antenna cable |
| 5 Black antenna cable | |

If the card has three triangles on the label (white, black, and gray), connect the white antenna cable to the white triangle, connect the black antenna cable to the black triangle, and connect the gray antenna cable to the gray triangle.

5. Replace the Bottom Access Panel (see [Replacing the Bottom Access Panel](#)).
6. Follow the procedures in [After Working on Your Computer](#).

6 WWAN Card

CAUTION: Before you begin any of the procedures in this section, follow the safety instructions that shipped with your computer.

NOTICE: Insert a WWAN card or FCM only into the slot shown in the picture below.

6.1 Removing a WWAN Card

1. Follow the procedures in [Before Working on Your Computer](#).
2. Remove the Bottom Access Panel (see [Removing the Bottom Access Panel](#)).
3. Disconnect the antenna cables from the card.
4. Remove the M2 x 3-mm screw. The card pops up at a 45-degree angle.

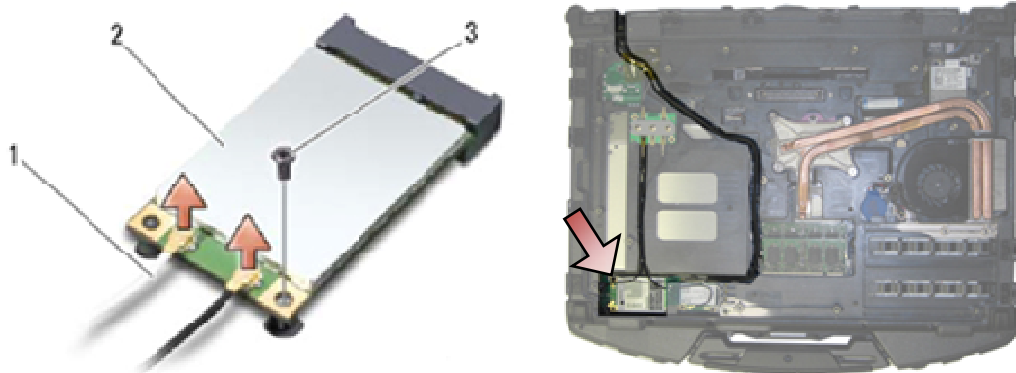

- | | |
|----------------------|-------------|
| 1 Antenna cables (2) | 2 WWAN card |
| 3 M2 x 3-mm screw | |

- Slide the card out of the card connector on the system board.

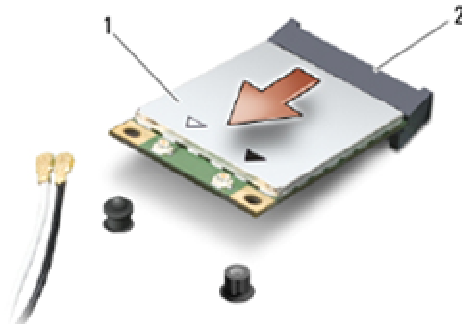

1 WWAN card 2 Card connector

6.2 Replacing a WWAN Card

- ➔ **NOTICE:** The connectors are keyed to ensure correct insertion. If you feel resistance, check the connectors on the card and on the system board, and realign the card.
 - ➔ **NOTICE:** To avoid damage to the WWAN card, ensure the cables are not under the card when you replace it.
 - ➔ **NOTICE:** Insert a WWAN card or FCM only into the slot labeled WWAN/WiMax.
- Slide the card into the connector labeled WWAN/FCM.
 - Press the card down and hold it in place.
 - Replace the M2 x 3-mm screw.
 - Connect the white antenna cable to the connector labeled "main" (white triangle), and connect the black antenna cable to the connector labeled "aux" (black triangle).
 - Replace the Bottom Access Panel (see [Replacing the Bottom Access Panel](#)).
 - Follow the procedures in [After Working on Your Computer](#).

7 WPAN (UWB/BT) Card

- ⚠ **CAUTION:** Before you begin any of the procedures in this section, follow the safety instructions that shipped with your computer.
- ➔ **NOTICE:** WPAN is a generic name for Ultra Wide Band (UWB) and Bluetooth® (BT). Insert a WPAN card only into the slot labeled WPAN/UWB/FCM.

7.1 Removing a WPAN (UWB/BT) Card

- Follow the procedures in [Before Working on Your Computer](#).
- Remove the Bottom Access Panel (see [Removing Bottom Access Panel](#)).
- Disconnect the blue antenna cable from the card.
- Remove the M2 x 3-mm screw. The card pops up at a 45-degree angle.

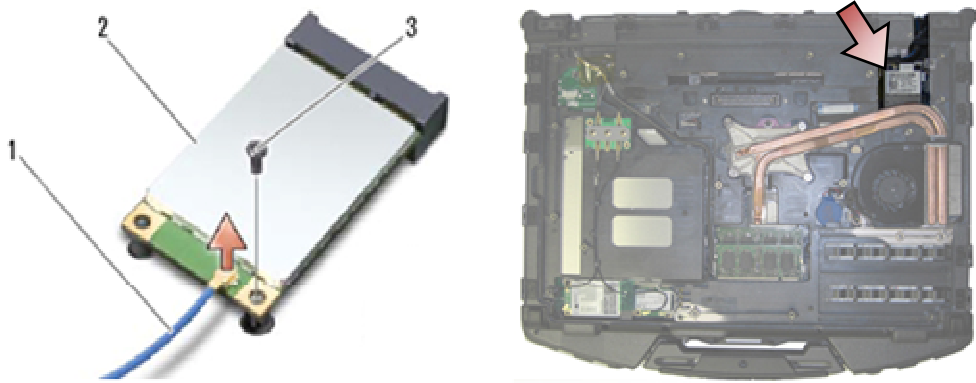

- 1 Antenna cable
- 2 WPAN card
- 3 M2 x 3-mm screw

5. Slide the card out of the card connector on the system board.

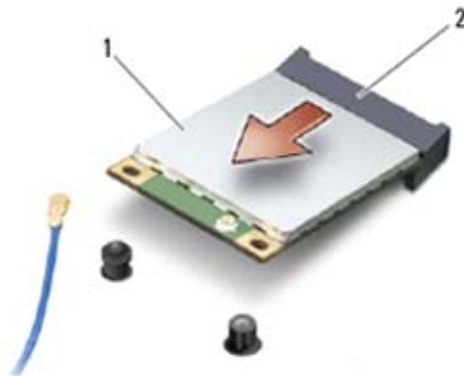

- 1 WPAN card
- 2 Card connector

7.2 Replacing a WPAN (UWB/BT) Card

- ➔ **NOTICE:** The connectors are keyed to ensure correct insertion. If you feel resistance, check the connectors on the card and on the system board, and realign the card.
- ➔ **NOTICE:** To avoid damage to the WPAN card, ensure the cables are not under the card when you replace it.
- ➔ **NOTICE:** Insert a WPAN card only into the slot labeled WPAN/UWB/FCM.

1. Slide the card into the connector labeled WPAN/UWB/FCM.



NOTE: The insertion of the card is considered a blind insert since the connector is not visible. Please take proper precautions during assembly to verify connection is set before securing the card.

2. Press the card down and hold it in place.
3. Replace the M2 x 3-mm screw.
4. Connect the blue antenna cable to the WPAN card.
5. Replace the Bottom Access Panel (see [Replacing the Bottom Access Panel](#)).
6. Follow the procedures in [After Working on Your Computer](#).

8 FCM

CAUTION: Before you begin any of the procedures in this section, follow the safety instructions that shipped with your computer.

The FCM is also known as Intel® Turbo Memory and the Intel Flash Cache Logic Chip Mini-card. You can install an FCM in either the WWAN/FCM card connector or the WPAN/UWB/FCM card connector.

NOTE: This module is only compatible with the Microsoft® Windows Vista® operating system.

8.1 Removing a FCM from the WWAN/FCM Slot

1. Follow the procedures in [Before Working on Your Computer](#).
2. Remove the bottom access panel (see [Removing the Bottom Access Panel](#)).
3. Remove the M2 x 3-mm screw. The FCM pops up at a 45-degree angle.
4. Slide the FCM out of the card connector on the system board.

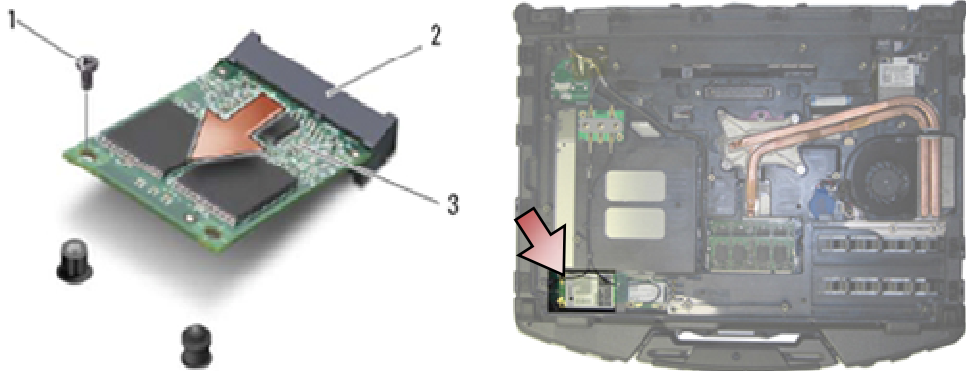

- | | | | |
|---|-----------------|---|----------------|
| 1 | M2 x 3-mm screw | 2 | Card connector |
| 3 | FCM | | |

8.2 Removing a FCM from the WPAN/UWB/FCM Slot

1. Follow the procedures in [Working on Your Computer](#).
2. Remove the bottom access panel (see [Removing the Bottom Access Panel](#)).
3. Remove the M2 x 3-mm screw. The FCM pops up at a 45-degree angle.
4. Slide the FCM out of the card connector on the system.

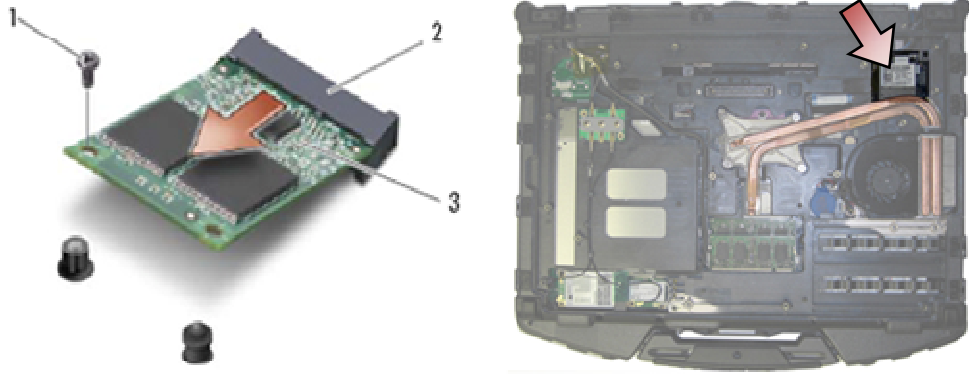

- 1 M2 x 3-mm screw 2 Card connector
3 FCM

8.3 Replacing a FCM

➔ **NOTICE:** When installing this module, ensure that the antenna cables are not under the card. Place the antenna cables in the holder next to the module. Installing the module on top of these antenna cables may cause damage to your system.

➔ **NOTICE:** The connectors are keyed to ensure correct insertion. If you feel resistance, check the connectors on the card and on the system board, and realign the card.

➔ **NOTICE:** An FCM can be installed in the WWAN/FCM card connector or the WPAN/UWB/FCM card connector. Use whichever card connector is available. If both are available, use the WWAN/FCM card connector, which is easier to access.

1. Slide the FCM into the card connector on the system board.
2. Press the FCM down and hold it in place.
3. Replace the M2 x 3-mm screw.
4. Secure the wireless cables. If you are installing the FCM in the WWAN/FCM slot, place the gray/black and gray/white antenna cables in the holder next to the module.

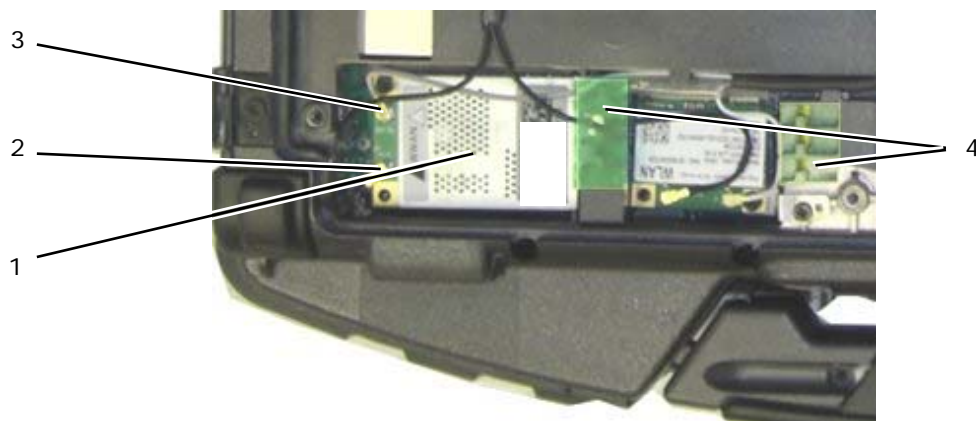

- 1 FCM/WWAN Card 2 Gray/black antenna cable
3 Gray/white antenna cable 4 Holder by module

5. Replace the bottom access panel (see [Replacing the Bottom Access Panel](#)).
6. Follow the procedures in [After Working on Your Computer](#).

9 RF Passthru Board

9.1 Removing the RF Passthru Board

⚠ CAUTION: Before you begin any of the procedures in this section, follow the safety instructions that shipped with your computer.

1. Follow the procedures in [Before Working on Your Computer](#).
2. Remove the bottom access panel (see [Removing the Bottom Access Panel](#)).
3. Disconnect the 5 antenna connections from the RF Passthru board.

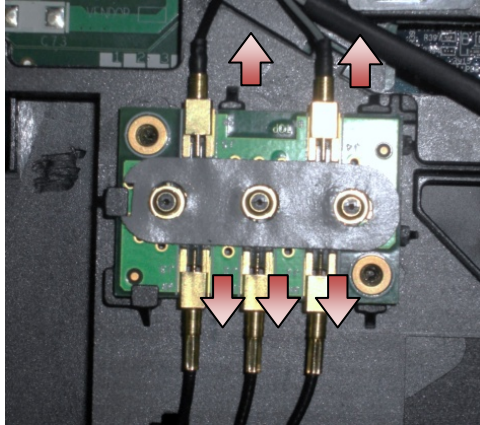

4. Gently lift the lower-right corner of the RF Passthru board, and remove the RF Passthru board by sliding it out of the chassis socket.

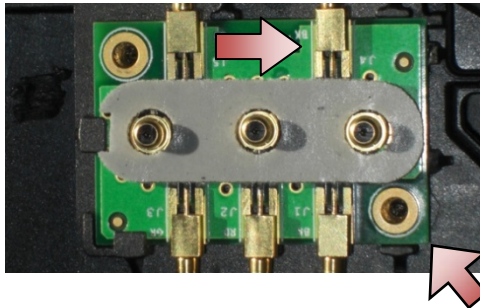

9.2 Replacing the RF Passthru Board

1. Slide the RF Passthru into the chassis socket as shown.
2. Gently press the edge of the RF Passthru board to ensure a secure fit to the base assembly.

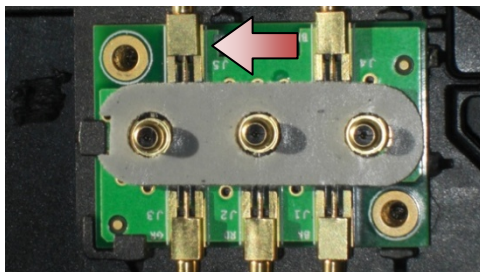

3. Connect the antenna connections to the RF Passthru board.

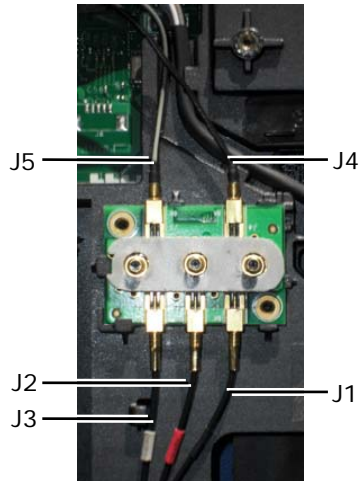

- J1 Black – WLAN (to WLAN card)
- J2 Black/Red Sleeve – GPS (to GPS card)
- J3 Black/Grey Sleeve – WWAN (to WWAN card)
- J4 Black – WLAN (from LCD panel antenna)
- J5 Black/Grey – WWAN (from LCD panel antenna)

4. Replace the bottom access panel (see [Replacing the Bottom Access Panel](#)).
5. Follow the procedures in [After Working on Your Computer](#).

10 Fan Assembly

10.1 Removing the Fan Assembly

⚠ CAUTION: Before you begin any of the procedures in this section, follow the safety instructions that shipped with your computer.

1. Follow the instructions in [Before Working on Your Computer](#).
2. Remove the bottom access panel (see [Removing the Bottom Access Panel](#)).
3. Remove the three M2.5 x 5-mm screws that secure the fan to the base assembly.

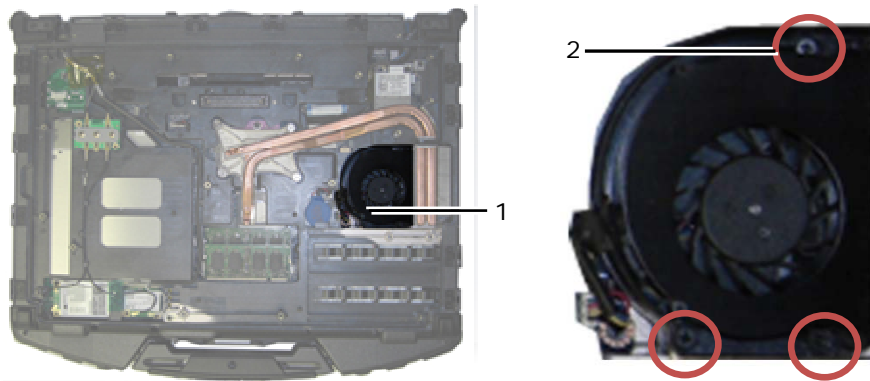

1 Fan 2 M2.5 x 5-mm screws (3)

4. Disconnect the fan cable from the system board.

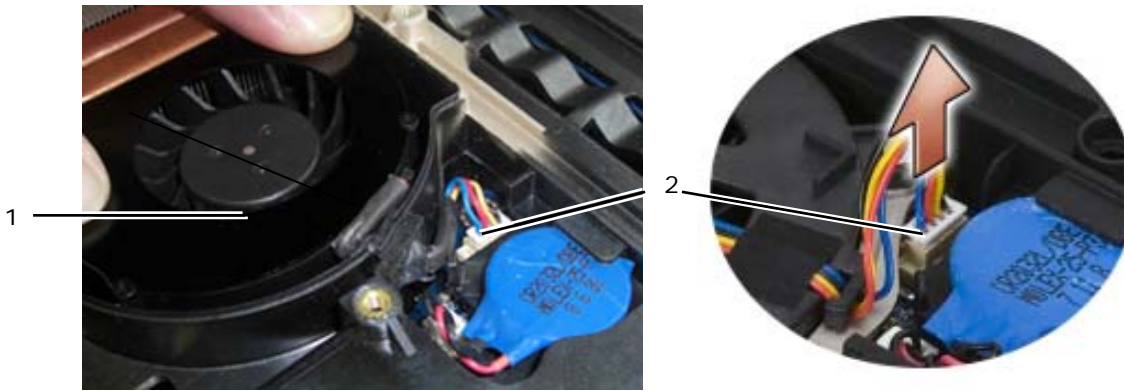

1 Fan 2 Fan cable

5. Lift the fan straight up to remove it.

10.2 Replacing the Fan Assembly

⚠ CAUTION: Before you begin any of the procedures in this section, follow the safety instructions that shipped with your computer.

1. Insert the fan.
2. Align the screw holes in the fan with the screw holes in the base assembly.
3. Replace the three M2.5 x 5-mm screws to secure the fan to the base assembly.
4. Align the gasket on the fan cable to the cutout in the base chassis and slide into place.
5. Connect the fan cable to the system board.
6. Replace the bottom access panel (see [Replacing the Bottom Access Panel](#)).
7. Follow the procedures in [After Working on Your Computer](#).

11 Processor Heatsink Assembly

11.1 Removing the Processor Heatsink Assembly

⚠ CAUTION: Before you begin any of the procedures in this section, follow the safety instructions that shipped with your computer.

1. Follow the instructions in [Before Working on Your Computer](#).
2. Remove the bottom access panel and fan assembly (see [Removing the Fan Assembly](#)).
3. In sequential order, loosen the four captive screws that secure the processor heatsink assembly to the system board.
4. Carefully lift the processor plate of the assembly up at an angle.
5. Remove the radiator from the computer.



- 1 Captive screws (4)
- 2 Radiator
- 3 Processor plate

11.2 Replacing the Processor Heatsink Assembly

CAUTION: Before you begin any of the procedures in this section, follow the safety instructions that shipped with your computer.

1. Place the radiator into the computer at an angle and set the processor plate in place.
2. Align the four captive screws on the processor plate with the screw holes on the system board.
3. In sequential order, tighten the four captive screws to secure the processor plate to the system board.
4. Replace the fan and bottom access panel (see [Replacing the Fan Assembly](#)).
5. Follow the procedures in [After Working on Your Computer](#).

12 Processor Module

12.1 Removing the Processor Module

CAUTION: Before you begin any of the procedures in this section, follow the safety instructions that shipped with your computer.

1. Follow the instructions in [Before Working on Your Computer](#).
2. Remove the bottom access panel, fan assembly and processor heatsink assembly (see [Removing the Processor Heatsink Assembly](#)).

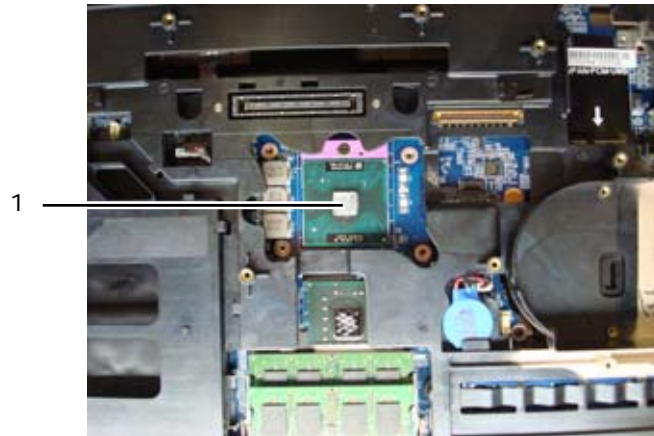

1 Processor module

- ➔ **NOTICE:** To avoid damage to the processor module, hold the screwdriver so that it is perpendicular to the processor when turning the cam screw.
- 3. To loosen the ZIF socket, use a small, flat-blade screwdriver and rotate the ZIF-socket cam screw counterclockwise until it comes to the cam stop.

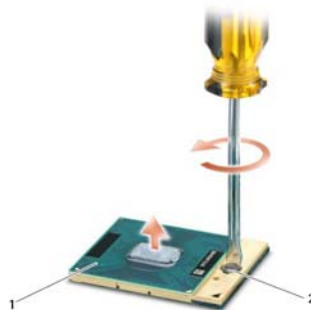

1 ZIF socket 2 ZIF-socket cam screw

- ➔ **NOTICE:** To ensure maximum cooling for the processor module, do not touch the heat transfer areas on the processor heatsink assembly. The oils in your skin can reduce the heat transfer capability of the thermal pads.
- ➔ **NOTICE:** When removing the processor, pull the processor straight up. Be careful not to bend the pins on the processor module.
- 4. Lift the processor module from the ZIF socket.

12.2 Replacing the Processor Module

- ⚠ **CAUTION:** Before you begin any of the procedures in this section, follow the safety instructions that shipped with your computer.
- ➔ **NOTICE:** Do not touch the processor die. Press and hold the processor module down on the substrate on which the die is mounted while turning the cam screw to prevent intermittent contact between the cam screw and processor.
- ➔ **NOTICE:** Ensure that the cam lock is in the fully open position before seating the processor module. Seating the processor module properly in the ZIF socket does not require force. A processor module that is not properly seated can result in an intermittent connection or permanent damage to the microprocessor and ZIF socket.

NOTE: If a new processor is installed, you will receive a new thermal grease kit along with a tech sheet to illustrate proper installation.

1. Align the pin-1 corner of the processor with the pin-1 corner of the ZIF socket, and then insert the processor.

NOTE: The pin-1 corner of the processor has a triangle that aligns with the triangle on the pin-1 corner of the ZIF socket, then insert the processor.

When the processor is properly seated, all four corners are aligned at the same height. If one or more corners of the processor are higher than the others, the processor is not seated properly.

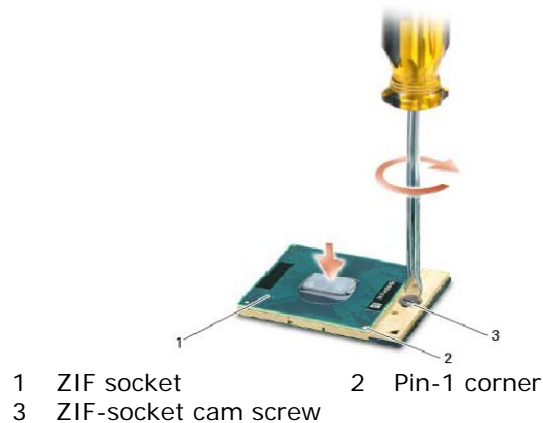

NOTICE: To avoid damage to the processor, hold the screwdriver so that it is perpendicular to the processor when turning the cam screw.

2. Tighten the ZIF socket by turning the cam screw clockwise to secure the processor to the system board.
3. Clean the heatsink. Use the cleaning pad provided with the processor kit to remove any old thermal grease between the 3 captive screws.
4. Apply the thermal grease. Follow the instructions provided with the processor kit, use the syringe to apply thermal grease in a spiral pattern to the processor thermal-cooling assembly.

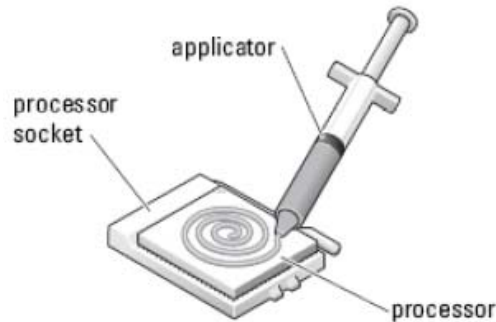

5. Replace the processor heatsink assembly (see [Replacing the Processor Heatsink Assembly](#)).
6. Follow the procedures in [After Working on Your Computer](#).

13 Memory

Your computer has two user-accessible SODIMM sockets. You can increase your computer memory by installing memory modules on the system board. See "Specifications" in your *Setup and Features Information Guide* for information on the memory supported by your computer. Install only memory modules that are intended for your computer.

NOTE: Memory modules purchased from Dell are covered under your computer warranty.

13.1 Removing a Memory Module

⚠ CAUTION: Before you begin any of the procedures in this section, follow the safety instructions that shipped with your computer.

➡ NOTICE: If two memory modules are installed, you must remove the top memory module first to access the bottom memory module.

5. Follow the procedures in [Before Working on Your Computer](#).
6. Remove the bottom access panel (see [Removing the Bottom Access Panel](#)).

➡ NOTICE: To prevent damage to the memory module connector, do not use tools to spread the memory module securing clips.

7. Use your fingertips to carefully spread apart the securing clips on each end of the memory module connector until the memory module pops up.
8. Remove the memory module from the connector.

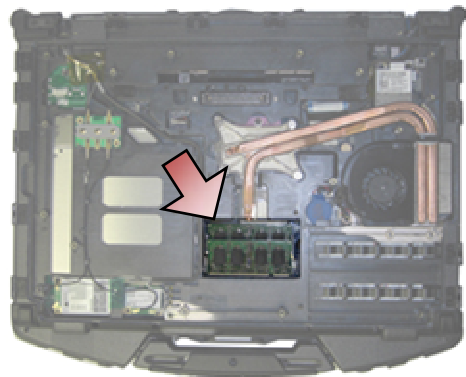
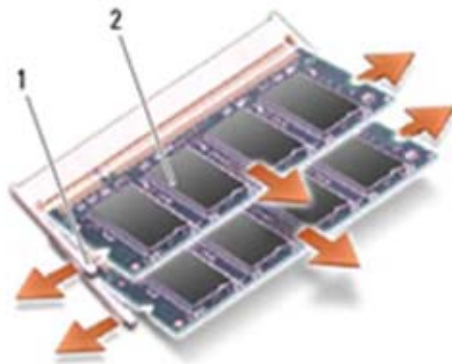

1 Securing clips (2) 2 Memory module

13.2 Replacing a Memory Module

⚠ CAUTION: Before you begin any of the procedures in this section, follow the safety instructions that shipped with your computer.

➡ NOTICE: If you are installing two memory modules, you must install the bottom memory module first.

1. Place the module at a 45-degree angle, and align the notch in the module with the tab on the connector.

✎ NOTE: If the memory module is not installed properly, the computer may not boot. No error message indicates this failure.

2. Press down on the module until it clicks into place. If the module does not click into place, remove the module and reinstall it.

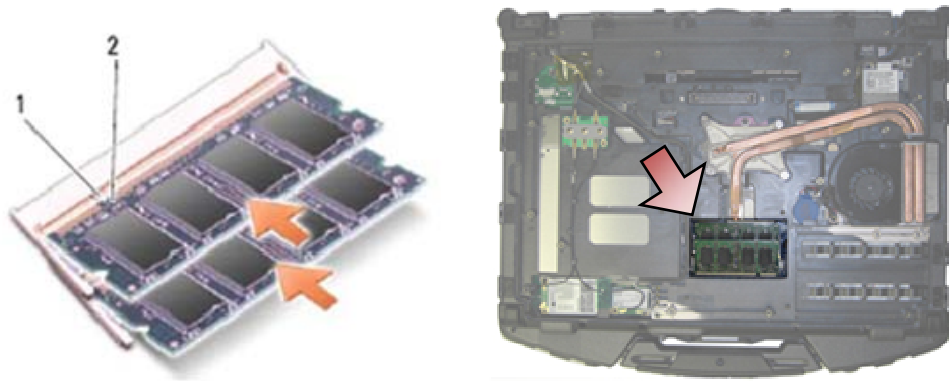

1 Tab 2 Notch

3. Replace the bottom access panel (see [Replacing the Bottom Access Panel](#)).
4. Follow the procedures in [After Working on Your Computer](#). As the computer boots, it detects the additional memory and automatically updates the system configuration information. To confirm the amount of memory installed in the computer:
 - In Windows XP, right-click the **My Computer** icon on your desktop. Click **Properties** → **General**.
 - In Windows Vista, click **Start** → **Help and Support** → **Dell System Information**.

14 Coin-Cell Battery

14.1 Removing the Coin-Cell Battery

CAUTION: Before you begin any of the procedures in this section, follow the safety instructions that shipped with your computer.

1. Follow the procedures in [Before Working on Your Computer](#).
2. Remove the bottom access panel (see [Removing the Bottom Access Panel](#)).
3. Pry up the coin-cell battery to release the double-stick adhesive tape on the bottom of the coin-cell battery, and then lift it out of the computer.
4. Disconnect the coin-cell battery cable from the system board.

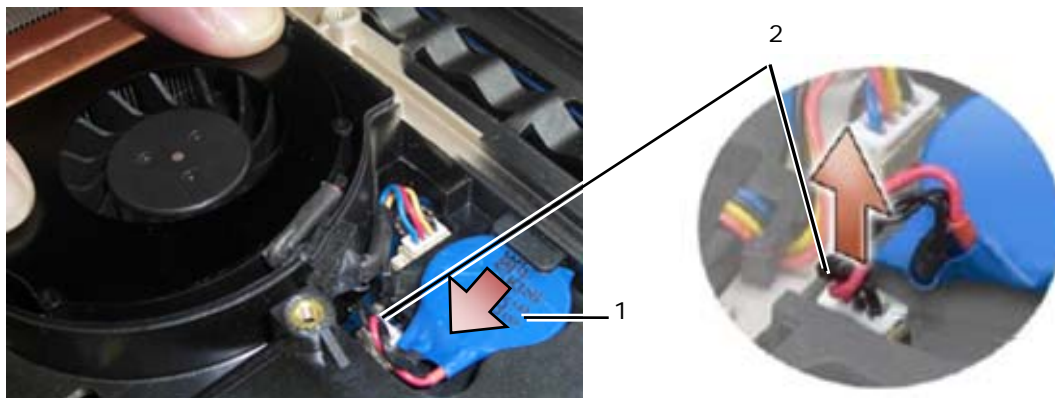

1 Coin-cell battery 2 Coin-cell battery cable

14.2 Replacing the Coin-Cell Battery

⚠ CAUTION: Before you begin any of the procedures in this section, follow the safety instructions that shipped with your computer.

1. Connect the coin-cell battery cable to the system board.
2. Insert the coin-cell battery into the computer:

If you are installing the same coin-cell battery you removed, slide the battery under the tab, then press down to seal the tape on bottom.

If you are installing a new coin-cell battery, first remove the adhesive backing paper from the coin-cell battery. Slide the battery under the tab, then press down to seal the tape on bottom.

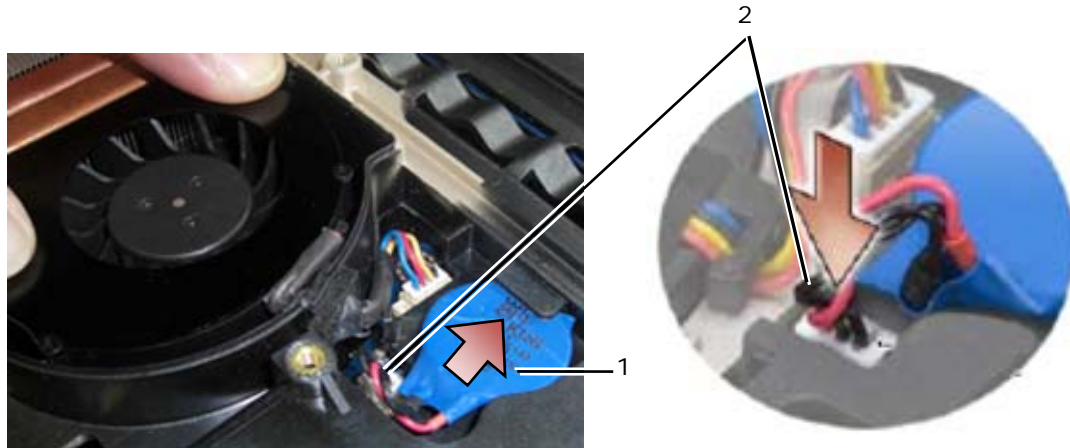

1 Coin-cell battery 2 Coin-cell battery cable

3. Replace the bottom access panel (see [Replacing the Bottom Access Panel](#)).
4. Follow the procedures in [After Working on Your Computer](#).

15 LED Cover

15.1 Removing the LED Cover

⚠ CAUTION: Before you begin any of the procedures in this section, follow the safety instructions that shipped with your computer.

1. Follow the procedures in [Before Working on Your Computer](#).
2. Remove the two M2.5 x 5-mm screws from the top of the LED cover.
3. There are 5 hooks on the bottom of the LED cover.

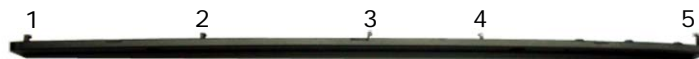

4. To release hook 1, gently push the LED cover from right to the left.

- While still applying pressure to the left, use a plastic scribe to pry up on the left corner of the LED cover.



- Scribe
- LED cover
- M2.5 x 5-mm screw (2)

- Hooks 2 and 3 are released individually by using a left and upward motion.
- Hook 4 is released by using a right and upward motion.
- Hook 5 is released by placing light left pressure on the assembly, then rotating the back edge slightly while prying with the plastic scribe.



15.2 Replacing the LED Cover

CAUTION: Before you begin any of the procedures in this section, follow the safety instructions that shipped with your computer.

- Working at an angle, snap the LED cover into place one hook at a time.
- Add the two M2.5 x 5-mm screws to secure the LED cover.
- Follow the procedures in [After Working on Your Computer](#).

16 Palm Rest Overlay

16.1 Removing the Palm Rest Overlay

CAUTION: Before you begin any of the procedures in this section, follow the safety instructions that shipped with your computer.

- Follow the procedures in [Before Working on Your Computer](#).
- Starting from the middle of the palm rest overlay, carefully peel the overlay away from the base.



3. After the middle is separated from the palm rest, peel the overlay from middle to left.



4. With the left half of the overlay removed, begin to work your way from middle to right.

16.2 Replacing the Palm Rest Overlay

⚠ CAUTION: Before you begin any of the procedures in this section, follow the safety instructions that shipped with your computer.

1. Remove the palm rest overlay adhesive protector.
2. Align the right side of the palm rest overlay in the palm rest groove ensuring the finger print reader (optional) is properly aligned.
3. Working your way from right to left, continuously press the overlay into place and ensure that it stays in the palm rest groove.
4. Follow the procedures in [After Working on Your Computer](#).

17 Keyboard

17.1 Removing the Keyboard

⚠ CAUTION: Before you begin any of the procedures in this section, follow the safety instructions that shipped with your computer.

1. Follow the procedures in [Before Working on Your Computer](#).
2. Remove the LED cover (see [Removing the LED Cover](#)).
3. Remove the palm rest overlay (see [Removing the Palm Rest Overlay](#)).
4. Loosen the two M2.5 x 9.85-mm captive screws along the bottom of the keyboard in the keyboard bracket.



1 Keyboard bracket 2 Pull tab

5. Remove the keyboard bracket.

➔ **NOTICE:** The key caps on the keyboard are fragile, easily dislodged, and time-consuming to replace. Exercise care when removing and handling the keyboard.

6. Using the pull tab, gently lift the top of the keyboard and then pull back to disconnect the keyboard.

17.2 Replacing the Keyboard

⚠ **CAUTION:** Before you begin any of the procedures in this section, follow the safety instructions that shipped with your computer.

➔ **NOTICE:** The key caps on the keyboard are fragile, easily dislodged, and time-consuming to replace. Exercise care when removing and handling the keyboard.

1. Holding the top of the keyboard slightly above the computer, slide the bottom of the keyboard in at an angle, and fit the tabs and keyboard connector along the bottom of the keyboard beneath the front-inside edge of the palm rest.
2. Carefully press each side to snap the keyboard into place.
3. Replace the keyboard bracket.
4. Tighten the two M2.5 x 9.85-mm screws on the keyboard bracket. Do not over-tighten these screws. This causes the gasket to push out on the sides of the bracket and the palmrest overlay will not fit properly in the next step.
5. Replace the palm rest overlay (see [Replacing the Palm Rest Overlay](#)).
6. Replace the LED cover (see [Replacing the LED Cover](#)).
7. Follow the procedures in [After Working on Your Computer](#).

18 GPS Card (Optional)

18.1 Removing the GPS Card

⚠ **CAUTION:** Before you begin any of the procedures in this section, follow the safety instructions that shipped with your computer.

1. Follow the procedures in [Before Working on Your Computer](#).
2. Remove the palm rest overlay (see [Removing the Palm Rest Overlay](#)).
3. Remove the two M2.5 x 5-mm screws securing the GPS door and remove the door.

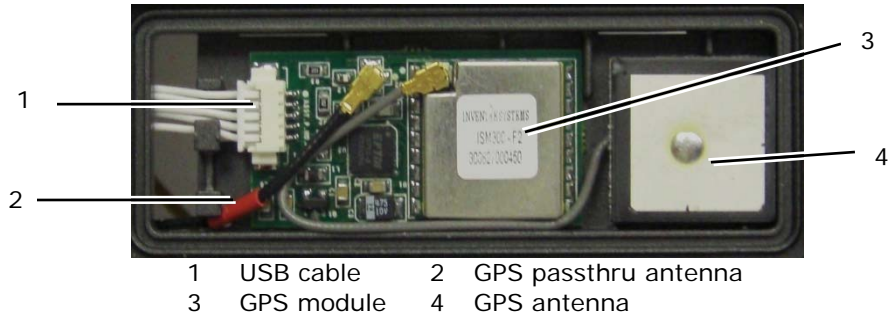

4. Detach the black and red RF Passthru antenna cable and the grey GPS antenna cable.
5. Using a scribe, gently detach the GPS card at the upper right corner of the card
6. Using a scribe, gently detach the GPS antenna at the upper left corner of the antenna.



1 Removal point for GPS card 2 Removal point for GPS antenna

7. Lift and move the GPS card to detach the USB data cable.



18.2 Replacing the GPS Card

1. Connect the GPS data cable to the GPS card.
2. Place the GPS card in the GPS bay of the palm rest.
3. Place the GPS antenna in the antenna bay.
4. Connect the Passthru cable to antenna connection (J2) and route properly.
5. Connect the GPS antenna to antenna connection (J1) and route properly.
6. Replace the GPS door to the palm rest using two 2.5 x 5-mm screws.
7. Replace the palm rest overlay (see [Replacing the Palm Rest Overlay](#)).
8. Follow the procedures in ([After Working On Your Computer](#)).

19 LCD Cable Channel Covers

19.1 Removing the LCD Cable Channel Covers

⚠ CAUTION: Before you begin any of the procedures in this section, follow the safety instructions that shipped with your computer.

🔧 NOTE: The cable covers are not interchangeable.

1. Follow the procedures in [Before Working on Your Computer](#).
2. Close the display and turn the computer upside down.
3. Remove the M2 x 3-mm screw from each cable cover.

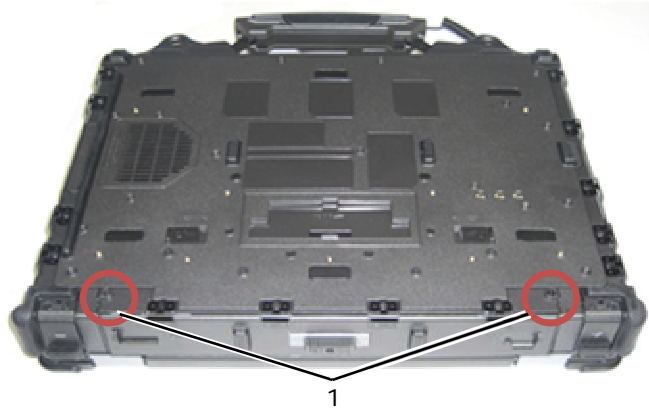

1 M2 x 3-mm screws (2)

4. Slide each cable cover up to remove.

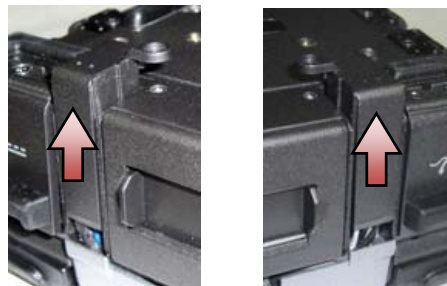

19.2 Replacing the LCD Cable Channel Covers

1. Remove the bottom access panel (see [Removing the Bottom Access Panel](#)).
2. Slide the cable covers on while holding the LCD wires taut.
3. Replace the bottom access panel (see [Replacing the Bottom Access Panel](#)).
4. Replace the M2x3-mm screw in each cable cover.
5. Follow the procedures in [After Working on Your Computer](#).

20 Display Assembly

20.1 Removing the Display Assembly

⚠ CAUTION: Before you begin any of the procedures in this section, follow the safety instructions that shipped with your computer.

1. Follow the instructions in [Before Working on Your Computer](#).
2. Remove the bottom access panel (see [Removing the Bottom Access Panel](#)).
3. Remove the LCD cable channel covers (see [Removing the LCD Cable Channel Covers](#)).

4. Disconnect and unroute the display cable and the wireless cables (WLAN, WWAN, and WPAN). Position all cables to the rear of the laptop after unrouting.

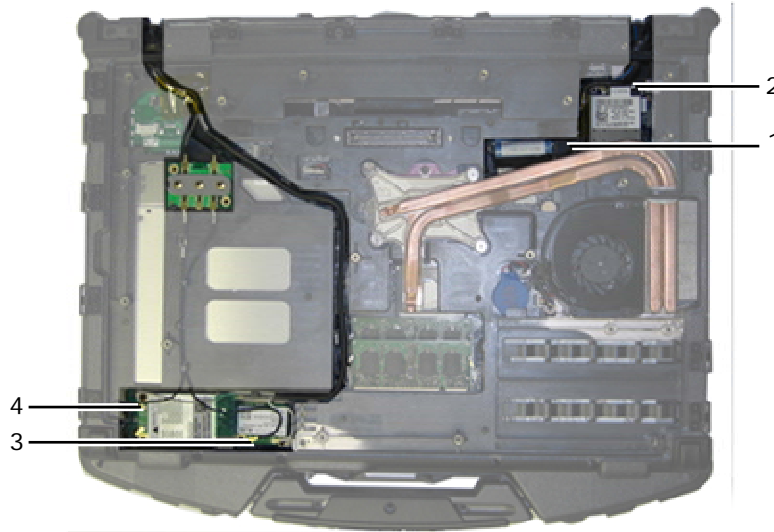

- | | | | |
|---|------------------------|---|------------|
| 1 | LVDS connector & cable | 2 | WPAN cable |
| 3 | WLAN cable | 4 | WWAN cable |

5. Disconnect the LVDS cable from the motherboard.
6. Disconnect the antenna cables from the top side connectors (J4 & J5) of the RF Passthru board.

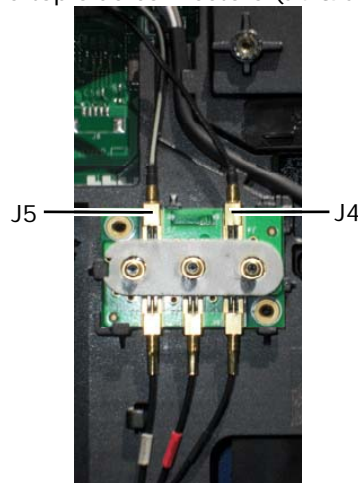

- | | |
|----|--|
| J4 | Black – WLAN (from LCD panel antenna) |
| J5 | Black/Grey – WWAN (from LCD panel antenna) |

7. Remove the display gaskets using your plastic scribe. Use an in-out motion altering sides on an individual gasket until the gasket is completely removed from the base. Once the gasket is pushed out of the base, route the rest of the cables thru the chassis bridge to remove LCD cables and antennas from the base.

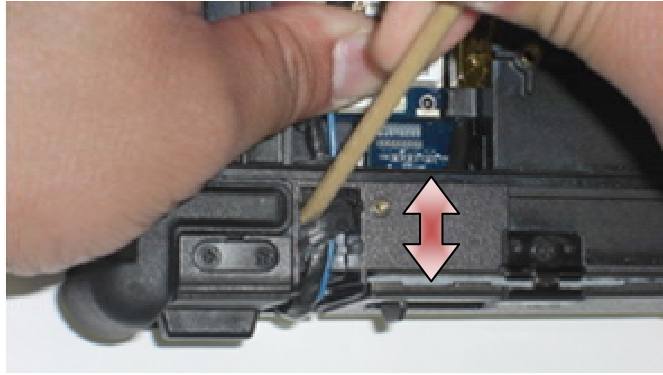

On the LVDS connector, rotate the blue pull-tab used to disconnect the cable from the system board to wrap the cable-side of the connector when routing through the chassis bridge.

8. Remove the three M2.5 x 8-mm screws from each hinge.
9. Turn the computer topside up.
10. Open the display to 90 degrees and lift the display assembly off the base assembly.



1 Display assembly 2 Base assembly

20.2 Replacing the Display Assembly

⚠ CAUTION: Before you begin any of the procedures in this section, follow the safety instructions that shipped with your computer.

1. Position the cables on the display assembly away from the base assembly.
2. Align the display hinges with the holes in the base of the computer, and lower the display into place.
3. Close the display and turn the computer upside down.
4. Replace the three M2.5 x 8-mm screws on each hinge. For each hinge, install the bottom side screw first, then install the two rear screws.
5. Route the cables through each chassis bridge.
6. On the LVDS connector, rotate the blue pull-tab used to disconnect the cable from the system board to wrap the cable-side of the connector when routing through the chassis bridge.



7. Install the display gaskets using your plastic scribe. Use a push motion altering sides on an individual gasket until the gasket is completely inserted into the chassis bridge.
8. Route the display cable and wireless (WLAN, WWAN, and WPAN) cables. Fit the cables under each tab in their respective routing channel.
9. Depending on the cards in your computer configuration, connect the antenna cables to their respective card: For WWAN, see [Replacing a WWAN Card](#). For WPAN, see [Replacing a WPAN \(UWB/BT\) Card](#). For WLAN, see [Replacing the WLAN/WiMax Card](#). Place any unused antenna cables in the base assembly cable holders next to the card slot.
10. If the system has the optional USB cable in the LCD assembly, reconnect the cable to the I/O board.



11. Connect the display cable to the display cable connector on the system board.
12. Connect the RF Passthru antenna cables (see [Replacing the RF Passthru Board](#)).
13. Replace the LCD cable channel covers (see [Replacing the LCD Cable Channel Covers](#)).
14. Replace the bottom access panel (see [Replacing the Bottom Access Panel](#)).
15. Follow the procedures in [After Working on Your Computer](#).

21 Palm Rest

21.1 Removing the Palm Rest

⚠ CAUTION: Before you begin any of the procedures in this section, follow the safety instructions that shipped with your computer.

1. Follow the instructions in [Before Working on Your Computer](#).
2. Remove the bottom access panel (see [Removing the Bottom Access Panel](#)).
3. Remove the display assembly (see [Removing the Display Assembly](#)).
4. Remove the keyboard (see [Removing the Keyboard](#)).
5. Remove the two M2.5 x 5-mm screws on each cable access panel. Remove the two cable access panels from the palm rest.

6. Disconnect the finger print reader cable (optional), the speaker cable, and the touch pad cable from the system board.
7. Lift the touch pad cable to reveal the contactless smart card cable underneath. Disconnect the contactless smartcard cable from the system board.
8. Disconnect the GPS antenna and USB connector (optional, see [Removing the GPS Card](#)).
9. Unroute the GPS antenna and USB connector from the palm rest.
10. Turn the computer over and remove the four M2.5 x 8-mm screws on the bottom of the computer.



11. Remove the one M2.5 x 5-mm screw on the motherboard between the fan and the fan connector.

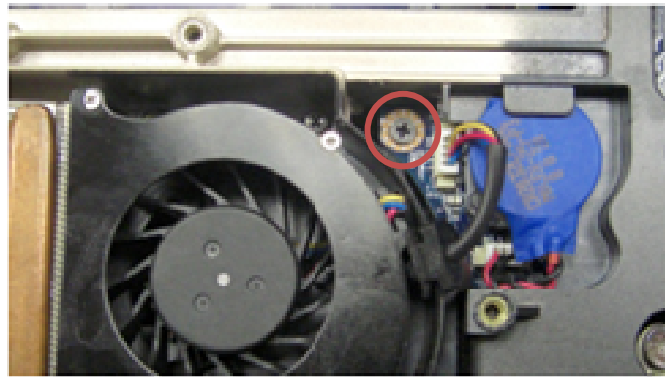

12. Turn the computer topside and remove the sixteen M2.5 x 8-mm screws on the top of the palm rest.

 **NOTE:** There are four snap hooks located in front of the mouse touchpad as part of the base assembly. These snap hooks may provide resistance during removal. To release the snaps, lift the LCD edge, of the palm rest, until the snap release.

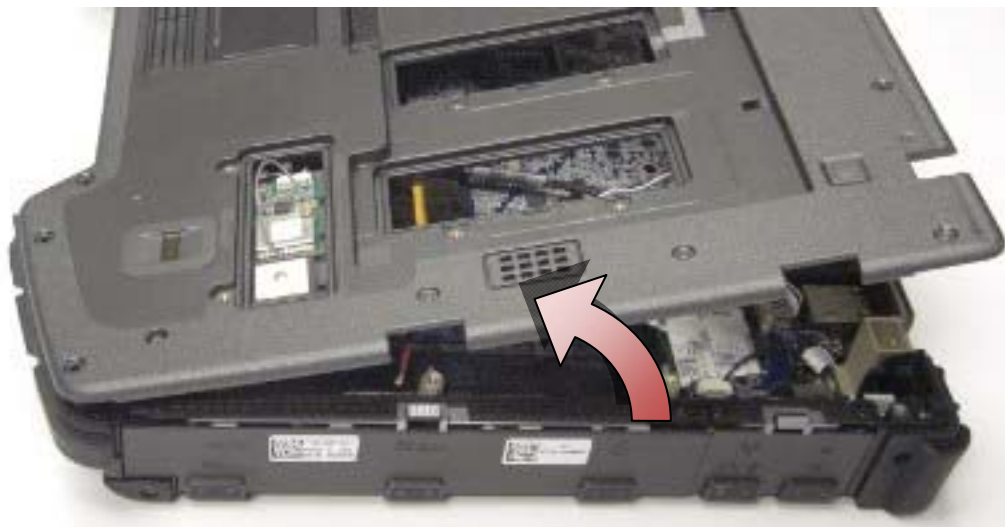

13. Lift the palm rest from the computer.

 **NOTE:** The handle will fall off when the palm rest is removed.

21.2 Replacing the Palm Rest

⚠ CAUTION: Before you begin any of the procedures in this section, follow the safety instructions that shipped with your computer.

🔧 NOTE: If this is a new palm rest, remove the two cable access panels, the GPS access panel and the keyboard bracket before installation.

1. Route the GPS antenna and USB connector through the channel guides in the GPS tray.



1 USB cable channel guide 2 GPS passthru antenna cable guide

2. Align the handle on the computer chassis (see [Replacing the Handle](#)).
3. Align the palm rest on the computer chassis.
4. Replace the 16 M2.5 x 8-mm screws on the top of the palm rest.
5. Apply slight pressure to the edge of the palm rest in front of the mousepad buttons until the snaps located below snap into place.



6. Turn the computer over and replace the four M2.5 x 8-mm screws on the bottom of the computer.
7. Replace the one M.2.5 x 5-mm screw on the motherboard between the fan and the fan connector.
8. Reconnect the GPS antenna and USB connector (optional: see [Replacing the GPS Card](#)).
9. Connect the contactless smartcard cable, the touchpad cable, the speaker cable, and the Finger print reader cable (optional) to the system board.
10. Replace the two cable access panels and secure each with two M2.5 x 5-mm screws.
11. Replace the keyboard, LED cover and palm rest overlay (see [Replacing the Keyboard](#)).
12. Replace the display assembly, LCD cable channel covers and bottom access panel (see [Replacing the Display Assembly](#)).
13. Follow the procedures in [After Working on Your Computer](#).

22 Modem

22.1 Removing the Modem

⚠ CAUTION: Before you begin any of the procedures in this section, follow the safety instructions that shipped with your computer.

1. Follow the procedures in [Before Working on Your Computer](#).

2. Remove the bottom access panel, LCD cable channel covers, display assembly, led cover, palm rest overlay, keyboard and palm rest (see [Removing the Palm Rest](#)).
3. Remove the M2 x 3-mm screw from the modem.
4. Use the pull tab to remove the modem from the I/O card.
5. Disconnect the modem cable from the modem.

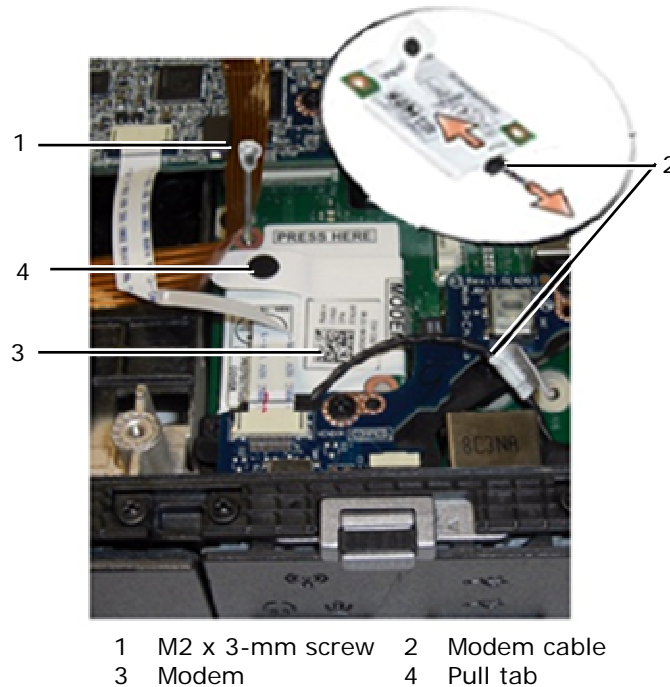

22.2 Replacing the Modem

⚠ CAUTION: Before you begin any of the procedures in this section, follow the safety instructions that shipped with your computer.

1. Connect the modem cable to the modem.
2. Use the screw hole on the modem to align it with the connector on the I/O card.
3. Press the area on the modem marked "Press Here" to connect the modem to the I/O card.
4. Replace the M2 x 3-mm screw to secure the modem to the I/O card.
5. Replace the palm rest, keyboard, palm rest overlay, LED cover, display assembly, LCD cable channel covers and bottom access panel (see [Replacing the Palm Rest](#)).
6. Follow the procedures in [After Working on Your Computer](#).

23 Smartcard Assembly

23.1 Removing the Smartcard Assembly

⚠ CAUTION: Before you begin any of the procedures in this section, follow the safety instructions that shipped with your computer.

1. Follow the procedures in [Before Working on Your Computer](#).
2. Remove the bottom access panel, LCD cable channel covers, display assembly, LED cover, palm rest overlay, keyboard and palm rest (see [Removing the Palm Rest](#)).
3. Remove the hard drive (see [Removing the Hard Drive](#)).
4. With the hard drive door open, carefully peel the smartcard gasket from the ceiling of the chamber opening.

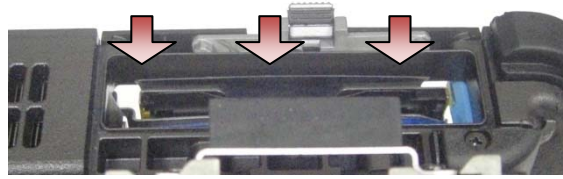

5. Remove the smartcard connector from the system board.
6. Remove the two M2 x 3-mm screws from the smartcard housing.

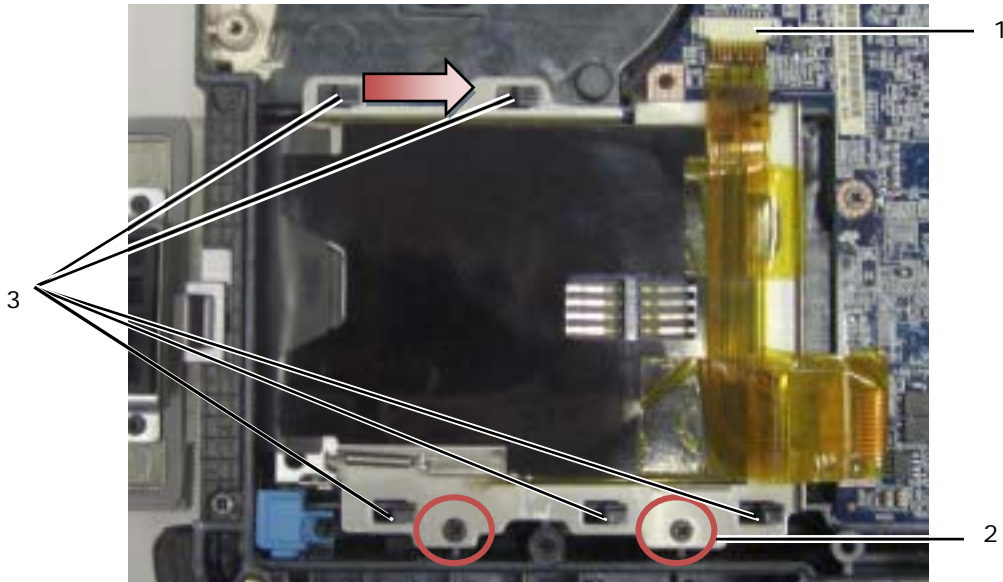

- 1 Smartcard connector 2 M2 x 3-mm screws (2)
 3 Chassis hooks (5)

7. Slide the smartcard housing to the right to disengage from the five chassis hooks.
8. Lift up to remove the smartcard housing from the base assembly.
9. Clean the surface of the hard drive chamber ceiling to remove contaminants or adhesive material.

23.2 Replacing the Smartcard Assembly

1. Set the smartcard assembly in place by aligning the rectangle openings with the tabs on the base assembly.
2. Place the smartcard gasket tongue into the hard drive chamber first, and then seat the smartcard assembly by aligning the rectangle openings with the chassis hooks.
3. Slide the smartcard housing left until the screw holes are aligned with the screw embossments.
4. Replace the two M2 x 3-mm screws.
5. Reconnect the smartcard cable into the system board.
6. Remove the tape backing from the smartcard gasket and adhere to the chamber ceiling.

NOTICE: If improperly installed, the Smartcard gasket may not allow a card to be inserted or removed from the smartcard reader. ALWAYS test insertion and removal after replacement.





7. Replace the palm rest, keyboard, palm rest overlay, LED cover, display assembly, LCD cable channel covers and bottom access panel (see [Replacing the Palm Rest](#)).
8. Follow the procedures in [After Working on Your Computer](#).

24 Hard Drive

NOTE: Dell does not guarantee compatibility or provide support for hard drives obtained from

sources other than Dell.

24.1 Removing the Hard Drive

-  **CAUTION:** Before you begin any of the procedures in this section, follow the safety instructions that shipped with your computer.
-  **CAUTION:** Do not touch the metal housing of the hard drive if you remove the hard drive from the computer while the drive is hot.
-  **NOTICE:** To prevent data loss, turn off your computer before removing the hard drive. Do not remove the hard drive while the computer is on or in Sleep state.
-  **NOTICE:** Hard drives are extremely fragile. Exercise care when handling the hard drive.

1. While following the procedures in [Before Working on Your Computer](#), open the hard disk drive door located on the left side panel by pushing the latch towards the rear of the computer, and then rotating the door down.

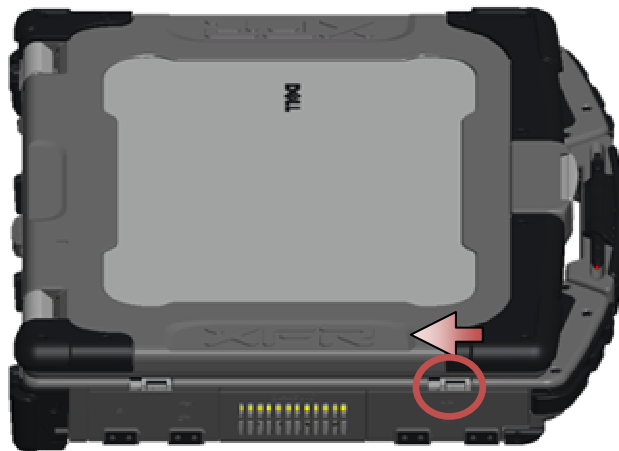

 **NOTE:** See hard drive removal instructions adhered to the edge of the hard drive.

2. Press in the blue locking button on the right side of the compartment.
3. While pressing in the blue locking button, use the tab on the edge of the hard drive to pull the hard drive from the compartment.

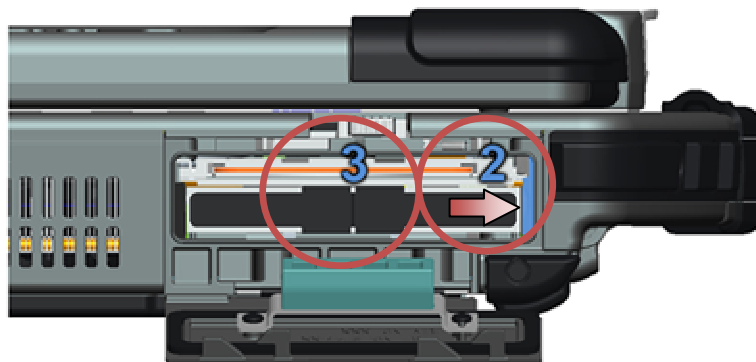

24.2 Replacing the Hard Drive

⚠ CAUTION: Before you begin any of the procedures in this section, follow the safety instructions that shipped with your computer.

➡ NOTICE: Hard drives are extremely fragile. Exercise care when handling the hard drive.

➡ NOTICE: Use firm and even pressure to slide the hard drive into place. Excessive force may result in damage to the connector.

1. Orient the hard drive to the computer. With the computer in its upright position, the text on the hard drive pull tab will be readable.
2. Slide the hard drive into the hard drive bay until you hear a click and a mechanical stop.
3. Close the hard disk drive door by rotating it up until it clicks into its locked position.
4. Follow the procedures in [After Working on Your Computer](#).
5. Install the operating system, drivers, and utilities for your computer, as needed. For more information, see the *Setup and Features Information Guide* that shipped with your computer or at support.dell.com.

25 Modular Drive

The modular drive supports either a second hard drive, an optical drive, or an air bay for travel.

25.1 Removing the Modular Drive

⚠ CAUTION: Before you begin any of the procedures in this section, follow the safety instructions that shipped with your computer.

🔧 NOTE: The security screw on the modular drive is optional and may not be installed on your computer.

1. Follow the procedures in [Before Working on Your Computer](#).
2. Open the modular (XBay) drive door located on the right side panel by pushing the latch towards the rear of the computer, and then rotating the door down.
3. Use the release latch to slide the drive out of the modular bay.

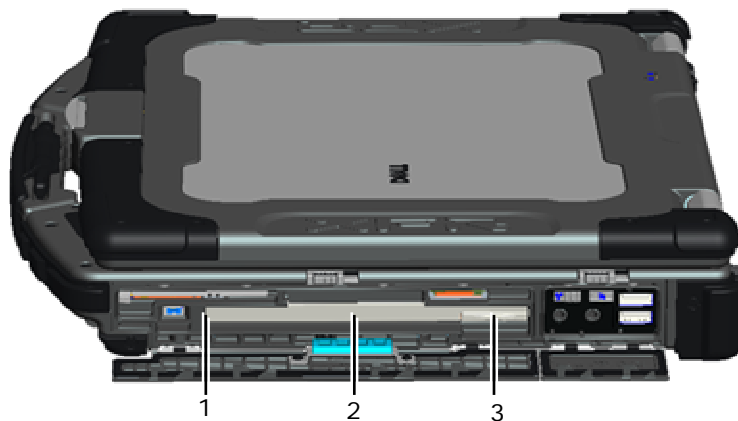

- 1 Modular bay 2 Modular drive
3 Release latch

25.2 Replacing the Modular Drive

⚠ CAUTION: Before you begin any of the procedures in this section, follow the safety instructions that shipped with your computer.

🔧 NOTE: The security screw on the modular drive is optional and may not be installed on your computer.

1. Slide the drive in the modular bay.
2. Close the modular (XBay) disk drive door by rotating it up until it clicks into its locked position.
3. Follow the procedures in [After Working on Your Computer](#).

26 System Board Assembly

The system board's BIOS chip contains the Service Tag, which is also visible on a barcode label on the bottom of the computer. The replacement kit for the system board includes media that provides a utility for transferring the Service Tag to the replacement system board.

NOTE: The replacement kit for the system board also includes media that provides a utility to set the system board as XFR, and a tech sheet for running this utility.

26.1 Removing the System Board Assembly

CAUTION: Before you begin any of the procedures in this section, follow the safety instructions that shipped with your computer.

1. Follow the instructions in [Before Working on Your Computer](#).
2. Remove the bottom access panel, LCD cable channel covers, display assembly, LED cover, palm rest overlay, keyboard, and palm rest and smartcard assembly (see [Removing the Palm Rest](#)).
3. Remove the VGA panel cover (see [Removing the VGA Panel Cover](#)).
4. Remove the coin-cell battery (see [Removing the Coin Cell Battery](#)).
5. Remove any mini-pci cards from the WWAN/FCM card slot, WLAN/WiMax card slot, and from the WPAN/UWB/FCM card slot, if present (see [Chapter 5, 6, 7 and 8](#) for removal procedures).
6. Remove the memory modules (see [Removing a Memory Module](#)).
7. Remove the fan, processor heatsink assembly and processor (see [Removing the Processor Module](#)).
8. Remove the hard drive (see [Removing the Hard Drive](#)).
9. Remove the modular drive (see [Removing the Modular Drive](#)).
10. Disconnect the Wi-Fi sniffer cable from the system board.
11. Disconnect the SIM card assembly from the system board (see [Removing the SIM Card Assembly](#)).
12. Disconnect the 1394 cable from the system board.
13. Remove the two M2 x 3-mm screws that secure the card cage to the chassis.
14. Remove eight M2.5 x 5-mm screws from the system board.

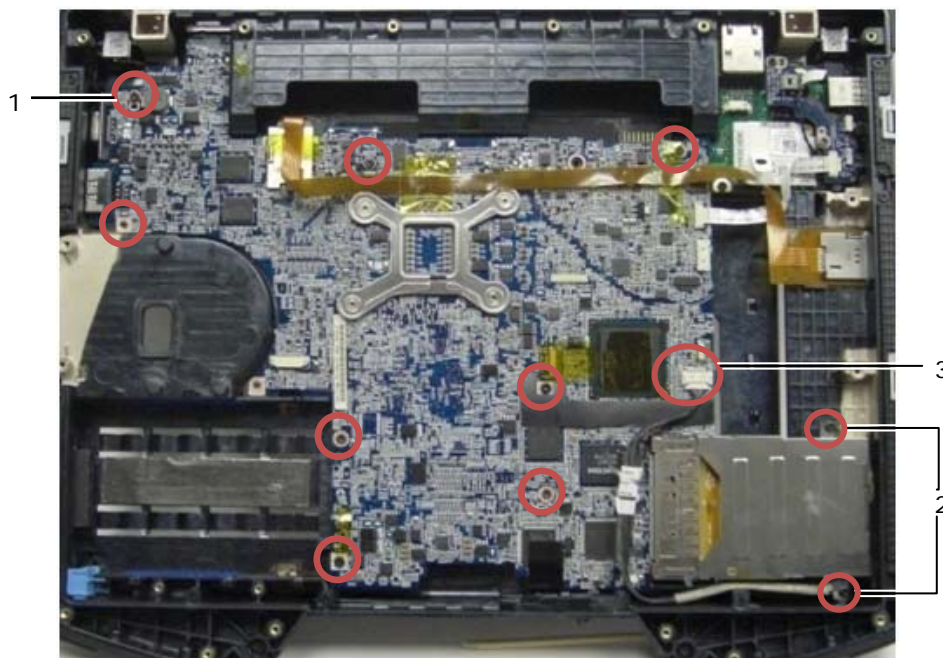

- 1 M2.5 x 5-mm screws (8)
- 2 M2 x 3-mm screws (2)
- 3 1394 connector

NOTE: Smartcard assembly removed to clarify screw locations and pinpoint system board connectors. The smartcard assembly should not be removed for system board or base assembly replacement.

- 15. Lift the back-right corner of the base assembly to release the I/O board connector. Gently lift the right side of board up while lifting the gasket at the multi-mode display port.
- 16. Remove the gasket from the multi-mode display port.
- 17. Slide the system board to the right to disengage it from the chassis.
- 18. Disconnect the DC cable, which is connected to the bottom of the system board.



- 19. Lift the system board out of the base assembly.
- 20. Remove the card cage (see [Removing the Card Cage](#)).

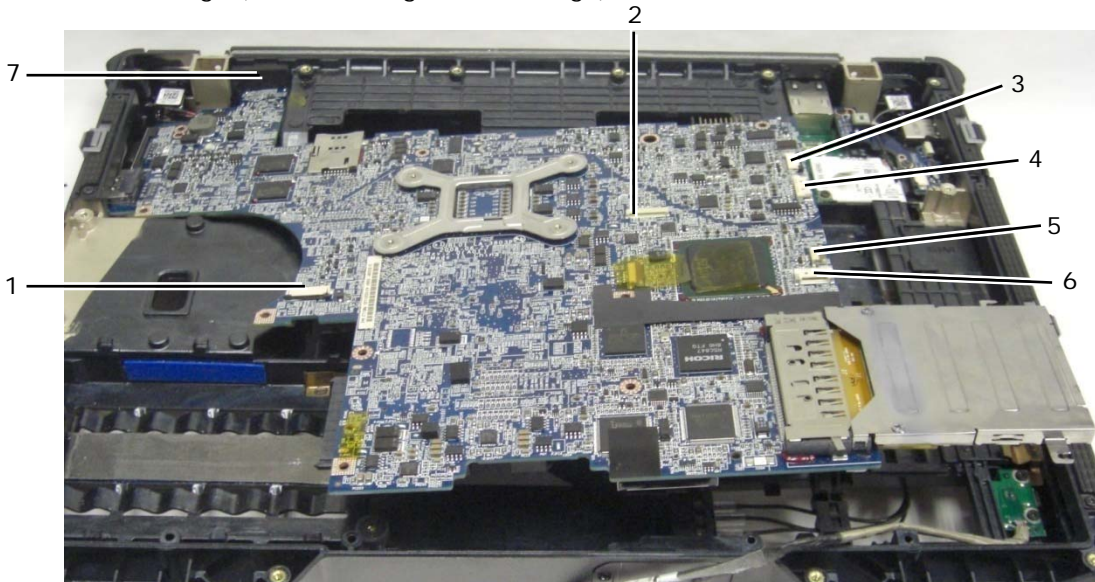

- | | | | | | |
|---|--------|-------------------------|---|-------|-------------------------------|
| 1 | JSC1 | Smartcard connector | 5 | JBIO1 | BIO reader connector |
| 2 | JTP1 | Touchpad connector | 6 | J1394 | 1394 cable connector |
| 3 | JSNIF1 | Wi-Fi sniffer connector | 7 | | Multi-mode HD video connector |
| 4 | JSPK1 | Speaker connector | | | |

26.2 Replacing the System Board Assembly

CAUTION: Before you begin any of the procedures in this section, follow the safety

instructions that shipped with your computer.

 **NOTICE:** Ensure that any loose cables do not get caught beneath the system board.

1. Replace the card cage to the system board, before installing into the computer (see [Replacing the Card Cage](#)).
2. Replace the gasket for the multi-mode display port.
3. Place the left-edge (VGA connector and USB/E-SATA Port) of the system board into the base of the computer, ensuring the system board fits through the VGA Panel, the gasket for the multi-mode HD video connector is set properly, and the cable for the smartcard assembly is not interfering.
4. Connect the DC power cable to the bottom of the system board.
5. Lay the system board into place and push down on the back-right corner of the system board to connect it to the I/O card.
6. Replace the eight M2.5 x 5-mm screws to the system board.
7. Replace the two M2 x 3-mm screws for the card cage.
8. Route and connect the 1394 card cable to the connector on the system board. Press down on the flat area of the cable to adhere it to the system board.
9. Install the Wi-Fi sniffer cable to the system board.
10. Connect the smartcard cable to the connector on the system board.
11. Replace the SIM card assembly (see [Replacing the SIM Card Assembly](#)).
12. Replace the palm rest, keyboard, palm rest overlay and LED cover (see [Replacing the Palm Rest](#)).
13. Replace the modular drive (see [Replacing the Modular Drive](#)).
14. Replace the hard drive (see [Replacing the Hard Drive](#)).
15. Replace the processor, heatsink assembly, and fan (see [Replacing the Processor Module](#)).
16. Replace the memory modules (see [Replacing a Memory Module](#)).
17. Replace the mini-pci cards in the WPAN/UWB/FCM card slot, WLAN/WiMax card slot, and/or WWAN/FCM card slot, if applicable (see [Chapters 5, 6, 7 and 8](#) for replacement procedures).
18. Replace the coin cell battery (see [Replacing the Coin Cell Battery](#)).
19. If you are installing a new system board, make a note of the number on the yellow label, located on the inside of the bottom access panel. You will need this number when you first power on the computer for AMT provisioning.
20. Replace the display assembly, LCD cable channel covers and bottom access panel (see [Replacing the Display Assembly](#)).
21. Follow the procedures in [After Working On Your Computer](#).
22. At first power on, the AMT provisioning menu appears. See the instructions in the tech sheet that was shipped with your replacement system board.
23. Enter the system setup program to update the BIOS on the new system board with the computer Service Tag. For information on the system setup program, see the *™ Technology Guide* on your computer or at support.dell.com.
24. Run the SetXFR utility to allow the system board to operate as an E6400 XFR computer. See the instructions in the tech sheet that was shipped with your replacement system board.

27 Card Cage

27.1 Removing the Card Cage

 **CAUTION:** Before you begin any of the procedures in this section, follow the safety instructions that shipped with your computer.

1. Follow the procedures in [Before Working on Your Computer](#).
2. Remove any PC-card or Express-card inserted.
3. Remove the system board (see [Removing the System Board](#)).
4. Slide the scribe under the cage then press outward to unhook the clips on both sides of the cage housing.



NOTE: Do NOT remove the two screws on the upper back corners of the card cage. They are used for retaining the card cage to the card extender board.

5. Detach the card extender board from the card socket by lifting the detached clips to clear the card socket and sliding the card cage from the card socket.



27.2 Replacing the Card Cage

CAUTION: Before you begin any of the procedures in this section, follow the safety instructions that shipped with your computer.

1. Insert the card extender into the card connector on the system board.



2. Rotate the retainer clips over the card connector and press the extender card into the socket. The extender is inserted properly if the white line on the PCB lines up with the metal cage of the system board connector.
3. Seat the retainer clips.
4. Replace the system board (see [Replacing the System Board](#)).

28 1394 Card

28.1 Removing the 1394 Card

⚠ CAUTION: Before you begin any of the procedures in this section, follow the safety instructions that shipped with your computer.

1. Follow the instructions in [Before Working on Your Computer](#).
2. Remove the card cage (see [Removing the Card Cage](#)).
3. Remove the two M2 x 3-mm screws.
4. Lift the 1394 card up at an angle to remove it.

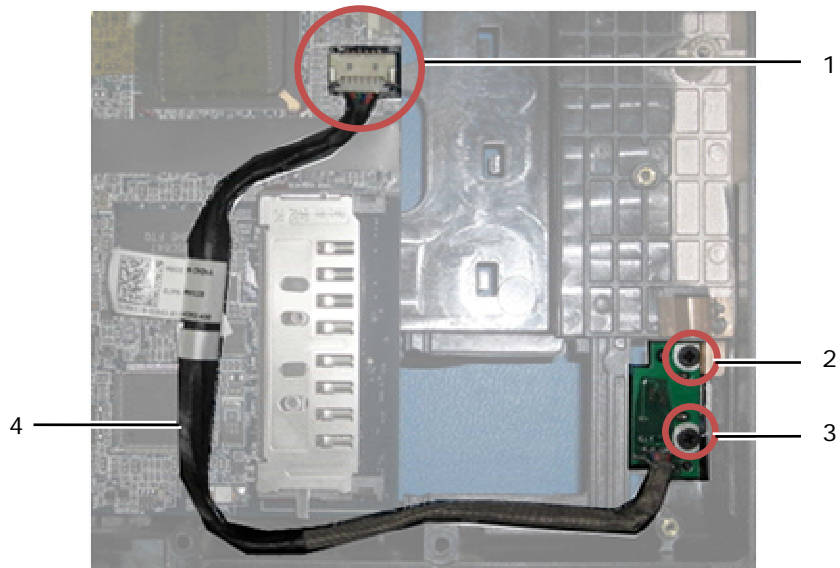

- | | | | |
|---|---------------------------------------|---|----------------------|
| 1 | 1394 cable connection to system board | 2 | M2 x 3-mm screws (2) |
| 3 | 1394 card | 4 | 1394 cable |

28.2 Replacing the 1394 Card

⚠ CAUTION: Before you begin any of the procedures in this section, follow the safety instructions that shipped with your computer.

1. Insert the 1394 card at a 45-degree angle to fit the connector into the base assembly. Use the alignment pins to seat into position.
2. Replace the two M2 x 3 screws.
3. Replace the card cage (see [Replacing the Card Cage](#)).
4. Follow the procedures in [After Working on Your Computer](#).

29 SIM Card

29.1 Removing the SIM Card Assembly

⚠ CAUTION: Before you begin any of the procedures in this section, follow the safety instructions that shipped with your computer.

1. Follow the instructions in [Before Working on Your Computer](#).
2. Remove the bottom access panel, LCD cable channel covers, display assembly, led cover, palm rest overlay, keyboard and palm rest (see [Removing the Palm Rest](#)).

3. Detach the tape and SIM card extension cable from the original SIM slot located on the left side of the battery bay, and place it out of the way.
4. Detach the Wi-Fi sniffer cable from the system board.
5. Using a scribe, gently place the edge under the SIM board and pry up.

 **NOTE:** Light force may be required as this board is taped to the base.

6. Lift the SIM card slot up at an angle and remove it.

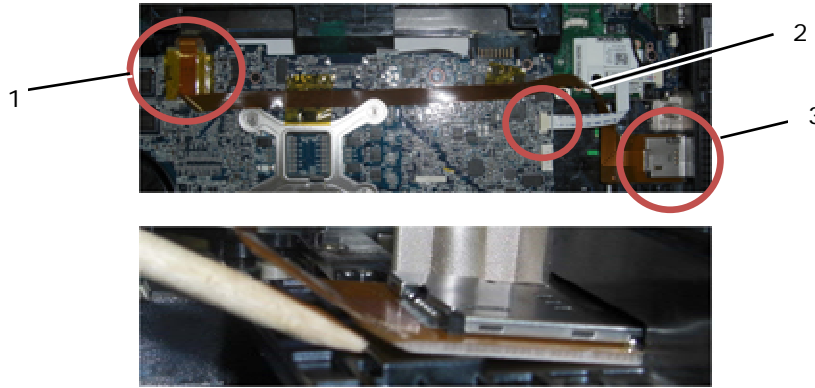

- 1 Original SIM card slot 2 Wi-Fi sniffer cable connection
3 SIM card board

29.2 Replacing the SIM Card Assembly

 **CAUTION:** Before you begin any of the procedures in this section, follow the safety instructions that shipped with your computer.

1. Remove the tape backing from the bottom of the SIM card assembly.
2. Insert the SIM card slot at a slight angle to fit the connector into the base assembly. Use the alignment planes to seat into position. The back of the board should fit against the planes.

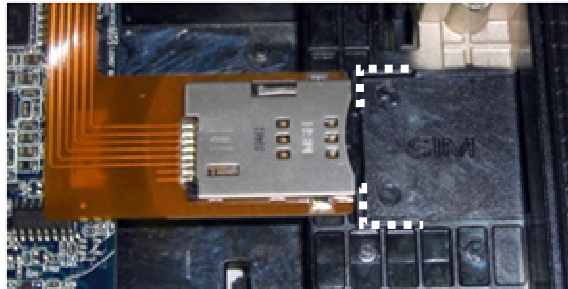

3. Route the SIM extension cable and reconnect the SIM extension board into the original SIM slot located in the battery bay.
4. Install the Wi-Fi sniffer cable to the system board.
5. Replace the palm rest, keyboard, palm rest overlay, led cover, display assembly, LCD cable channel covers and bottom access panel (see [Replacing the Palm Rest](#)).
6. Follow the procedures in [After Working on Your Computer](#).

30 Wi-Fi Sniffer Card

30.1 Removing the Wi-Fi Sniffer Card

1. Follow the procedures in [Before Working on Your Computer](#).

2. Remove the bottom access panel, LCD cable channel covers, display assembly, led cover, palm rest overlay, keyboard and palm rest (see [Removing the Palm Rest](#)).
3. Detach the Wi-Fi Sniffer cable from the motherboard.
4. Remove the M2 x 3-mm screw from the modem.
5. Detach the modem, and then rotate the modem and RJ-11 cable out of the way.



1 Wi-Fi Sniffer cable connection to motherboard

6. Remove the sniffer card by removing the two M2.5 x 5-mm screws that secure the card to its bracket.

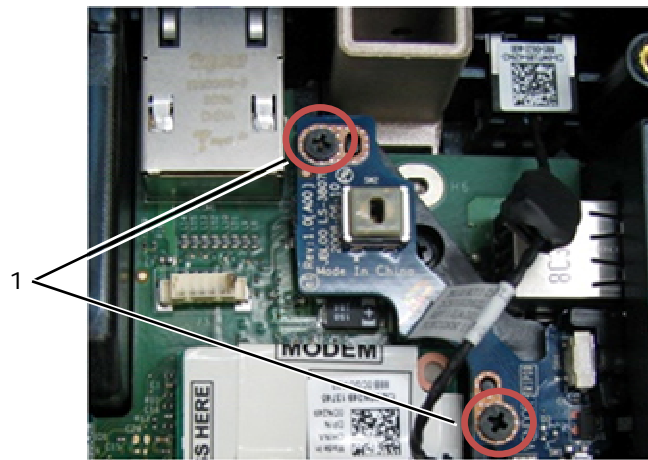

1 M2.5 x 5-mm screws (2)

30.2 Replacing the Wi-Fi Sniffer Card

1. Align the sniffer card with its bracket and secure it using the 2 M2.5 x 5-mm screws.
2. Connect the Wi-Fi sniffer cable to the motherboard.
3. Reseat the RJ-11 cable and replace the modem (see [Replacing the Modem](#)).
4. Replace the palm rest, keyboard, palm rest overlay, led cover, display assembly, LCD cable channel covers and bottom access panel (see [Replacing the Palm Rest](#)).
5. Follow the procedures in [After Working on Your Computer](#).

31 I/O Card

31.1 Removing the I/O Card

⚠ CAUTION: Before you begin any of the procedures in this section, follow the safety instructions that shipped with your computer.

1. Follow the procedures in [Before Working on Your Computer](#).
2. Remove the system board (see [Removing the System Board Assembly](#)).
3. Remove the modem (see [Removing the Modem](#)).
4. Remove the RJ-11 modem connector (see [Removing the RJ-11 Modem Connector](#)).
5. Remove the M2.5 x 5-mm screw from the I/O card.
6. Remove the sniffer card (see [Removing the Wi-Fi Sniffer Card](#)).
7. Remove the 2 M2.5 x 8-mm screws holding the sniffer card bracket, and remove the bracket.

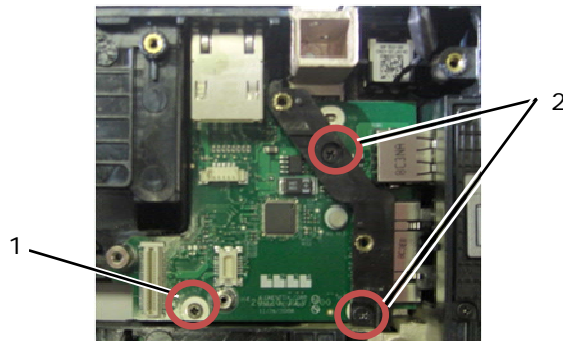

1 M2.5 x 5-mm screw 2 M2.5 x 8-mm screw (2)

8. Remove the I/O card.

31.2 Replacing the I/O Card

1. Replace the I/O card.
2. Replace the sniffer card bracket.
3. Replace the sniffer card (see [Replacing the Wi-Fi Sniffer Card](#)).
4. Replace the M2.5 x 5-mm screw from the I/O card.
5. Replace the RJ-11 modem connector (See [Replacing the RJ-11 Modem Connector](#)).
6. Replace the modem (see [Replacing the Modem](#)).
7. Replace the system board (see [Replacing the System Board Assembly](#)).
8. Follow the procedure for [After Working on Your Computer](#).

32 RJ-11 Modem Connector

32.1 Removing the RJ-11 Modem Connector

⚠ CAUTION: Before you begin any of the procedures in this section, follow the safety instructions that shipped with your computer.

1. Follow the procedures in [Before Working on Your Computer](#).
2. Remove the bottom access panel, LCD cable channel covers, display assembly, led cover, palm rest overlay, keyboard and palm rest (see [Removing the Palm Rest](#)).
3. Remove the modem (see [Removing the Modem](#)).
4. Pry up the RJ-11 modem connector to release the double-stick adhesive tape on the bottom of the connector, and then lift the RJ-11 modem connector out of the base assembly.

32.2 Replacing the RJ-11 Modem Connector

⚠ CAUTION: Before you begin any of the procedures in this section, follow the safety instructions that shipped with your computer.

1. Place the RJ-11 modem connector into the base assembly, aligning the guides on the connector sides with the base. Once installed, press down firmly on top of the RJ-11 connector to seal the adhesive to the base.
2. Replace the modem (see [Replacing the Modem](#)).
3. Replace the palm rest, keyboard, palm rest overlay, led cover, display assembly, LCD cable channel covers and bottom access panel (see [Replacing the Palm Rest](#)).
4. Follow the procedures in [After Working on Your Computer](#).

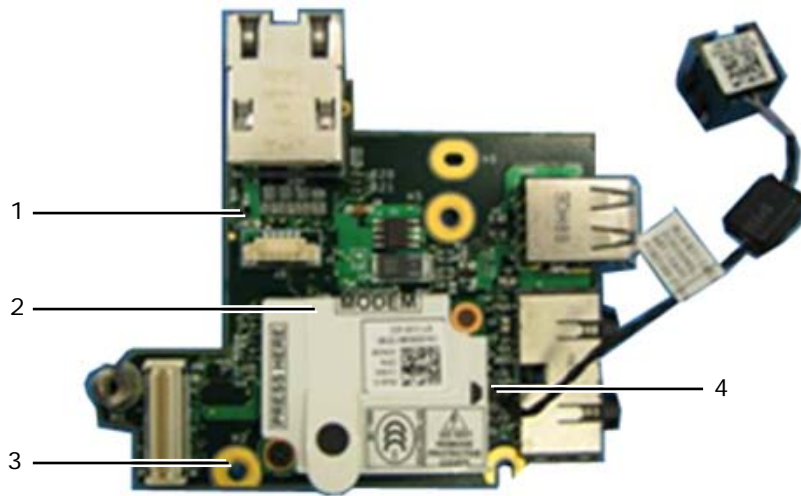

- | | | | |
|---|-------------------|---|------------------|
| 1 | I/O card | 2 | RJ-11 modem card |
| 3 | M2.5 x 5-mm screw | 4 | Modem connector |

33 DC Power Cable

33.1 Removing the DC Power Cable

⚠ CAUTION: Before you begin any of the procedures in this section, follow the safety instructions that shipped with your computer.

1. Follow the instructions in [Before Working on Your Computer](#).
2. Remove the system board (see [Removing the System Board Assembly](#)).

✎ NOTE: Do not remove the mini-pci wireless or FCM cards, memory modules, or processor from the system board.

3. Unroute the DC power cable from the base assembly. Pry up the DC power connector to release the double-stick adhesive tape on the bottom of the connector, and then lift the DC power connector out of the base assembly.

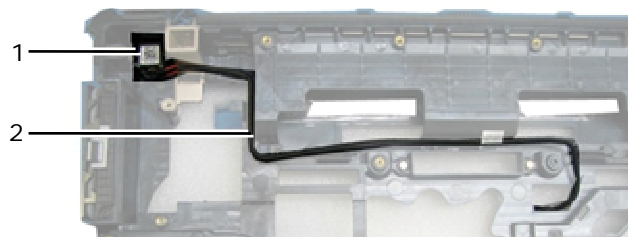

- | | | | |
|---|--------------------|---|----------|
| 1 | DC power connector | 2 | DC cable |
|---|--------------------|---|----------|

33.2 Replacing the DC Power Cable

⚠ CAUTION: Before you begin any of the procedures in this section, follow the safety instructions that shipped with your computer.

1. Place the DC power cable in the base assembly, aligning the guides on the connector sides with the base. Once installed, press down firmly on top of the DC power connector to seal the adhesive to the base.
2. Route the DC power cable in the base assembly.
3. Replace the system board (see [Replacing the System Board Assembly](#)).
4. Follow the procedures in [After Working on Your Computer](#).

34 Base Assembly

34.1 Removing the Base Assembly

1. Follow the procedures in [Before Working on Your Computer](#).
2. Remove the system board (see [Removing the System Board Assembly](#)).

✎ NOTE: Do not remove the mini-pci wireless or FCM cards, memory modules, or processor from the system board.

3. Remove the SIM card assembly (see [Removing the SIM Card Assembly](#)).
4. Remove the modem (see [Removing the Modem](#)).

34.2 Replacing the Base Assembly

1. Replace the modem (see [Replacing the Modem](#)).
2. Replace the system board (see [Replacing the System Board Assembly](#)).
3. Follow the procedures in [After Working on Your Computer](#).

35 Stylus

35.1 Removing the Stylus

1. Follow the procedures in [Before Working on Your Computer](#).
2. Remove the stylus from the stylus bay of the handle.
3. Close the display and turn the computer upside down.

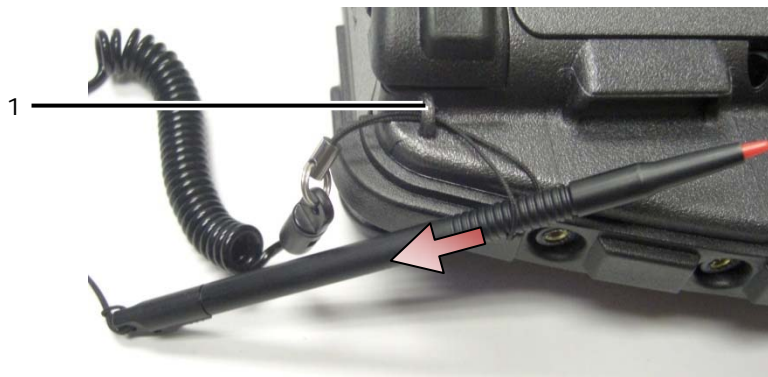

1 Tether anchor point

4. Run the stylus and tether through the tether loop, slide the lanyard from the loop then remove from unit.

35.2 Replacing the Stylus

1. Pinch the end of the tether loop to a point.
2. Place the tether loop, pointed end first, through the tether anchor at the edge of the system.
3. Run the stylus and tether through the tether loop.



4. Once the stylus and tether are completely through the tether loop, pull the stylus to secure the tether loop onto the tether anchor.
5. Insert stylus in stylus bay of the handle
6. Follow the procedures in [After Working on Your Computer](#).

36 Handle

36.1 Removing the Handle

CAUTION: Before you begin any of the procedures in this section, follow the safety instructions that shipped with your computer.

1. Follow the procedures in [Before Working on Your Computer](#).
2. Remove the six M2.5 x 8-mm screws from the front of the palm rest.

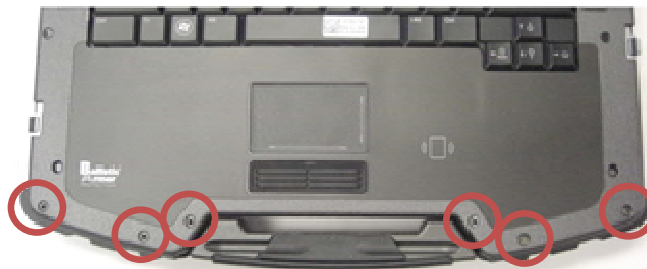

3. Turn the system over and remove the four M2.5 x 8-mm palm rest retainer screws.



4. Place a scribe against the handle socket on the side, press in 1 inch and rotate to the front to lift the palm rest area slightly.

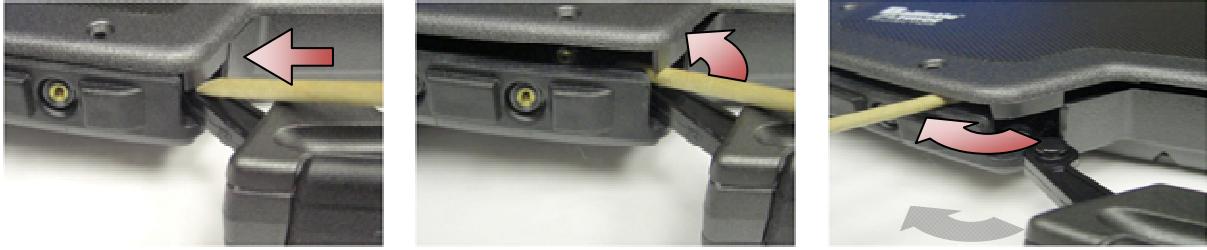

5. Remove the carry handle from the sockets and slide out of the notebook.

36.2 Replacing the Handle

1. Insert the carry handle pinion into the sockets on the base of the notebook.

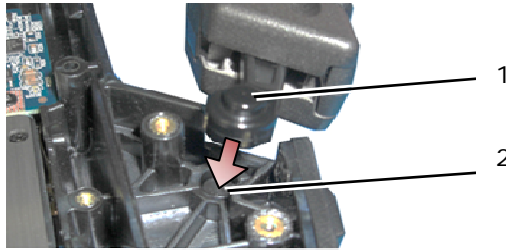

1 Handle pinion 2 Tab socket

NOTICE: Image above has palm rest removed to show tab socket close-up. During installation, verify handle pinions are inserted into the tab sockets properly during reassembly.

2. Replace the four M2.5 x 8-mm bottom retaining screws.
3. Replace the six M2.5 x 8-mm palm rest retaining screws.
4. Follow the procedures in [After Working on Your Computer](#).

37 Doors

37.1 Removing Media Bay Door

Parts

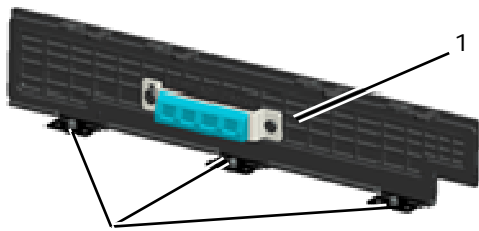

1 Media bay door 2 M3 x 3 mm screws (3)

Location



CAUTION: Before you begin any of the procedures in this section, follow the safety instructions that shipped with your computer.

1. Follow the procedures in [Before Working on Your Computer](#).

2. Open the door to relieve hinge pressure.
3. Remove the three M3 x 3-mm screws from the bottom of the base assembly

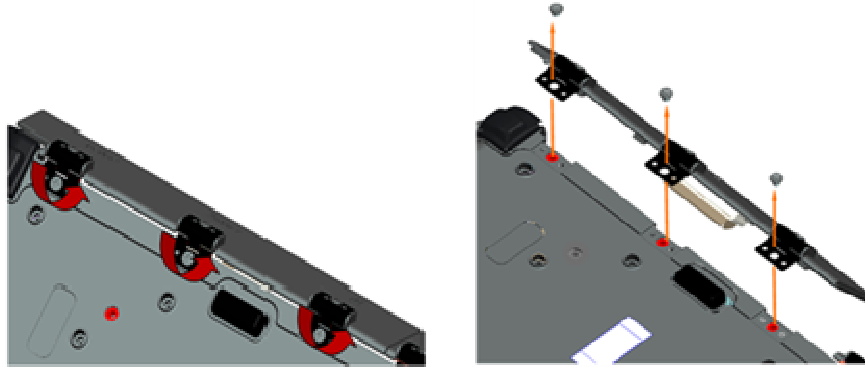

37.2 Replacing Media Bay Door

1. Insert door hinge onto assembly and align the hinge divots.

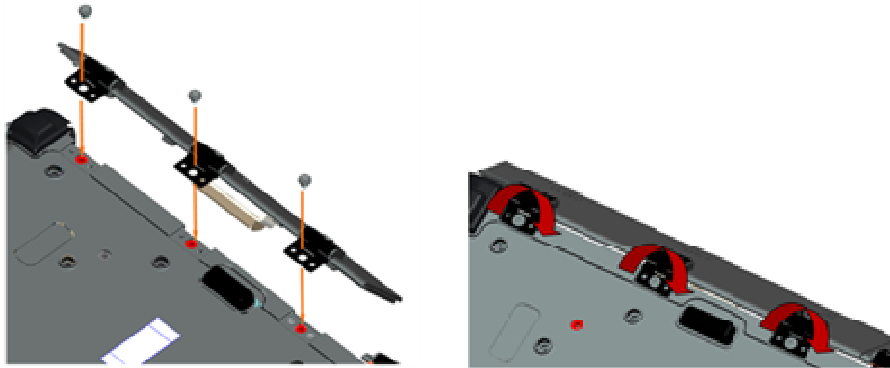

2. Insert the three M3 x 3-mm screws and fit securely.
3. Follow the procedures in [After Working on Your Computer](#).

37.3 Removing the AV Door

Parts

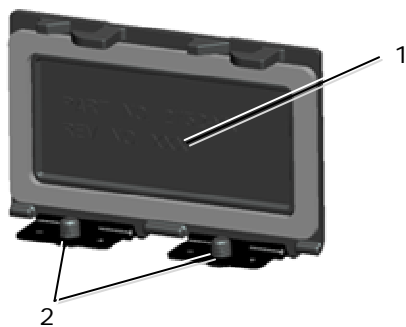

1 Door

2 M3 x 3 mm (2)

Location



1. Follow the procedures in [Before Working on Your Computer](#).
2. Open the door to relieve hinge pressure.
3. Remove the two M3 x 3-mm screws from the bottom of the base assembly.

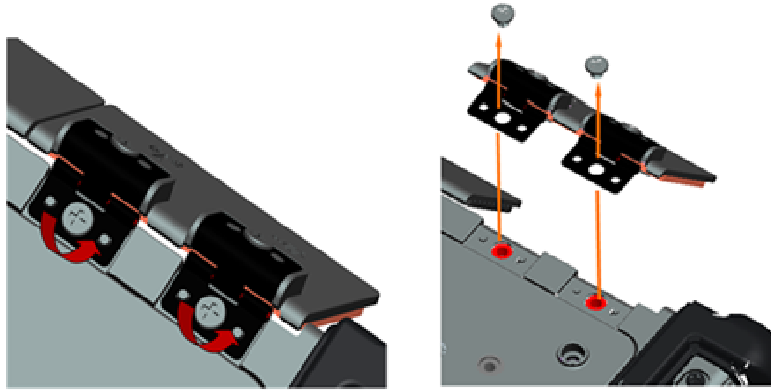

37.4 Replacing the AV Door

1. Insert door hinge onto assembly and align the hinge divots.
2. Replace the two M3 x 3-mm screws.
3. Follow the procedures in [After Working on Your Computer](#).

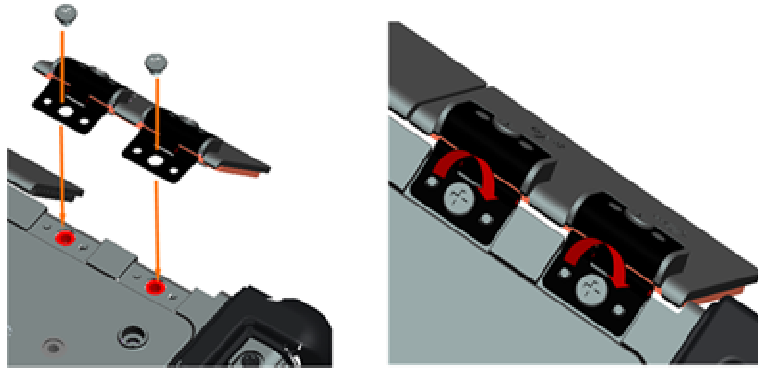

37.5 Removing the AV Panel Cover

1. Follow the procedures in [Before Working on Your Computer](#).
2. Open the AV door.
3. Place a scribe in the lower USB slot where there is a small opening on the side.
4. Pulling the scribe forward will disengage the cover snaps, remove the cover.



37.6 Replacing the AV Panel Cover

1. Place the AV Panel Cover on the guide pin.
2. Slide AV Panel Cover and lightly press in all four corners to snap the cover in place.
3. Follow the procedures in [After Working on Your Computer](#).

 **NOTE:** Failure to verify the Wi-Fi switch and sniffer button may leave the unit unable to power on

the wireless circuit. It is advised to check these options as soon as possible. See [Replacing the Wi-Fi Sniffer Card](#) for details.

37.7 Removing the RJ11 Door

Parts

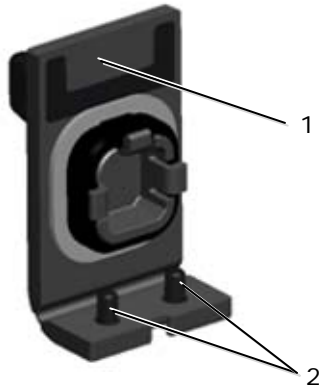

1 Door 2 M2.5 x 5-mm (2)

Location



1. Follow the procedures in [Before Working on Your Computer](#).
2. Open the door to relieve hinge pressure.
3. Remove the two M2.5 x 5-mm screws from the bottom of the base assembly

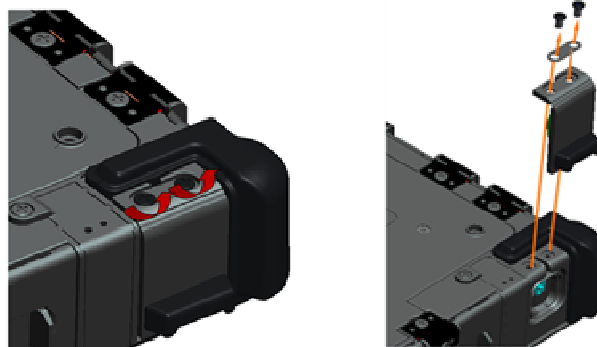

37.8 Replacing the RJ11 Door

1. Insert door hinge onto assembly and align the hinge divots.
2. Replace the two M2.5 x 5-mm screws.

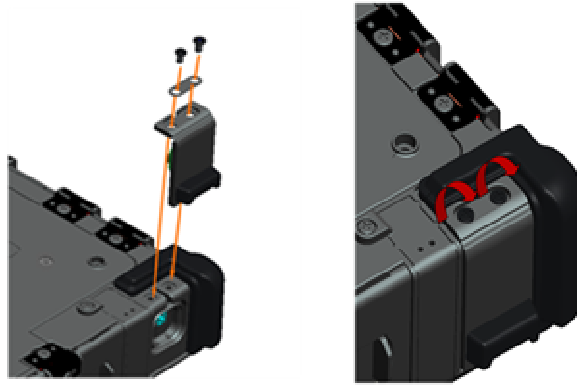

3. Follow the procedures in [After Working on Your Computer](#).

37.9 Removing the Battery Door

1. Follow the procedures in [Before Working on Your Computer](#).
2. Open the door to relieve hinge pressure.
3. Remove the four M3 x 3-mm screws from the bottom of the base assembly.

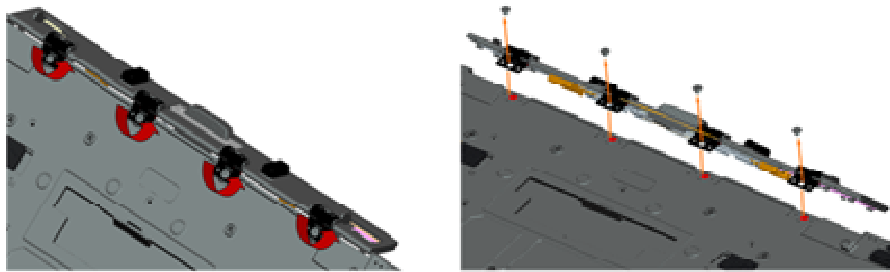

37.10 Replacing the Battery Door

1. Insert door hinge onto assembly and align the hinge divots.
2. Replace the four M3 x 3-mm screws.

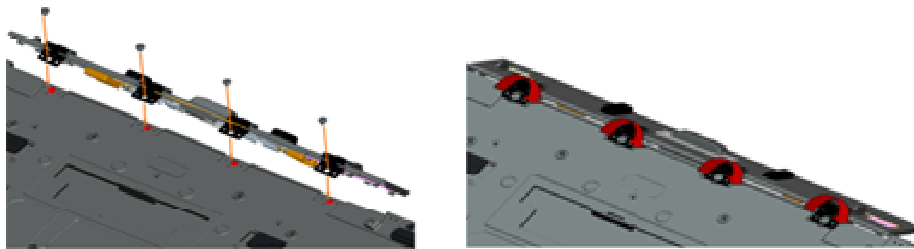

3. Follow the procedures in [After Working on Your Computer](#).

37.11 Removing the Power Door

Parts

Location



1 Door 2 M2.5 x 5-mm (2)

1. Follow the procedures in [Before Working on Your Computer](#).
2. Open the door to relieve hinge pressure.
3. Remove the two M2.5 x 5-mm screws from the bottom of the base assembly

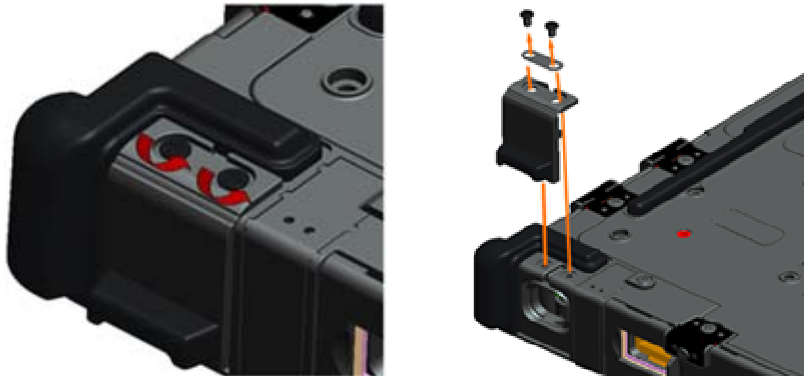

37.12 Replacing the Power Door

1. Insert door hinge onto assembly and align the hinge divots.
2. Replace the two M2.5 x 5-mm screws.

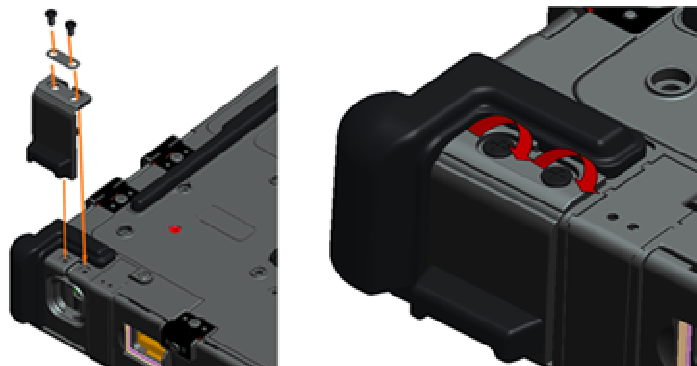

3. Follow the procedures in [After Working on Your Computer](#).

37.13 Removing the VGA Door

Parts

Location

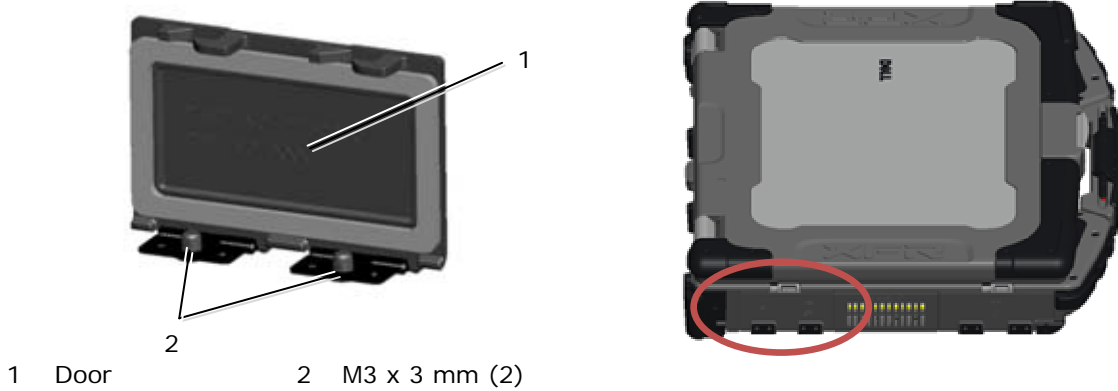

1. Follow the procedures in [Before Working on Your Computer](#).
2. Open the door to relieve hinge pressure.
3. Remove the two M3 x 3-mm screws from the bottom of the base assembly.

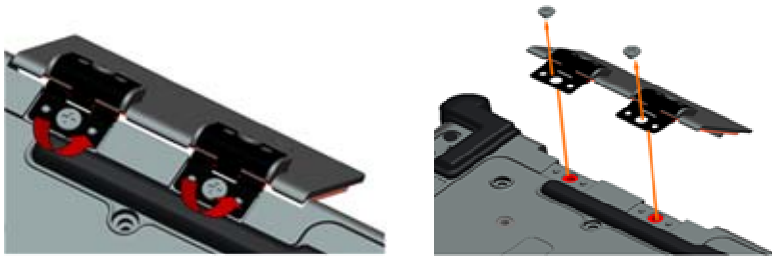

37.14 Replacing the VGA Door

1. Insert door hinge onto assembly and align the hinge divots.
2. Replace the two M3 x 3-mm screws.



3. Follow the procedures in [After Working on Your Computer](#).

37.15 Removing the VGA Panel Cover

1. Follow the procedures in [Before Working on Your Computer](#).
2. Open the VGA door.

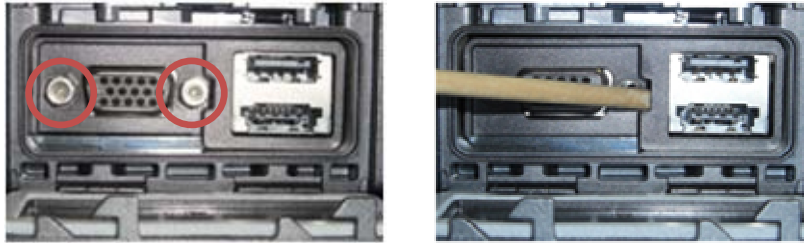

3. Remove the two VGA Connector socket screws.
4. Place a scribe in the small opening and pull to remove.

37.16 Replacing the VGA Panel Cover

1. Place the VGA Panel Cover in place over the VGA port.
2. Replace the two VGA connector socket screws.
3. Follow the procedures in [After Working on Your Computer](#).

37.17 Removing the HDD Door

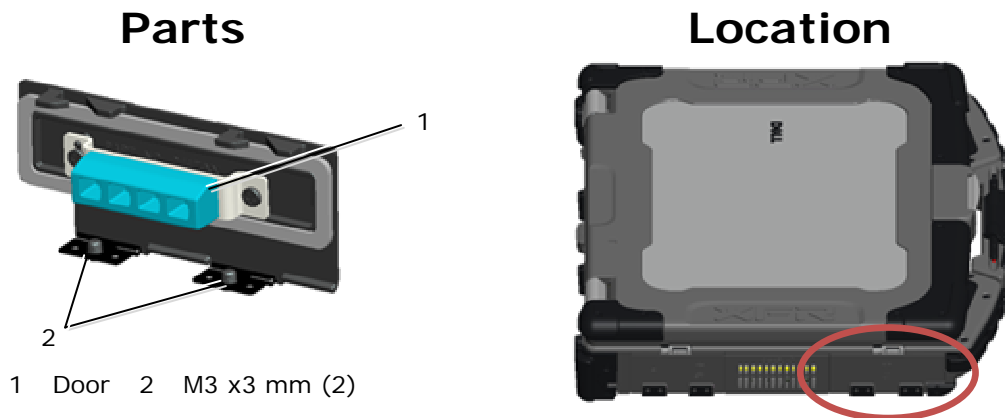

1. Follow the procedures in [Before Working on Your Computer](#).
2. Open the door to relieve hinge pressure.
3. Remove the two M3 x 3-mm screws from the bottom of the base assembly

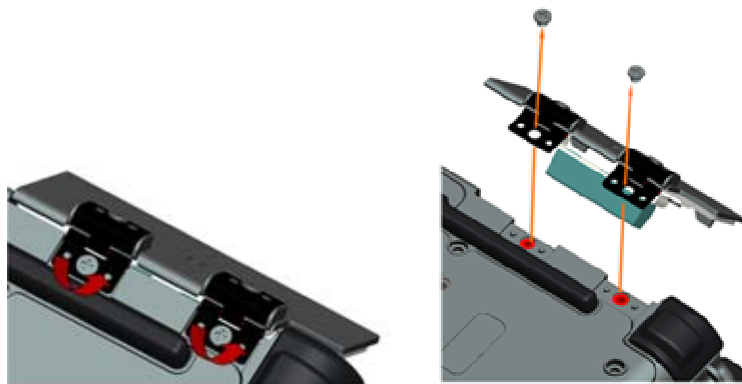

37.18 Replacing the HDD Door

1. Insert door hinge onto assembly and align the hinge divots.
2. Replace the two M3 x 3-mm screws.

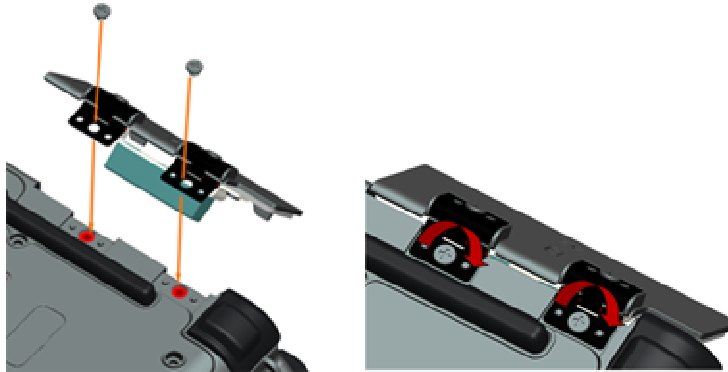

3. Follow the procedures in [After Working on Your Computer](#).

37.19 Removing the SD Card Door

Parts

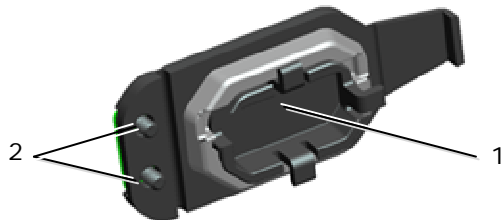

1 Door 2 M2.5 x 5-mm (2)

Location



1. Follow the procedures in [Before Working on Your Computer](#).
2. Open the door to relieve hinge pressure.
3. Remove the handle (see [Removing the Handle](#))
4. Remove the two M2.5 x 5-mm screws from the base assembly



37.20 Replacing the SD Card Door

1. Insert door hinge onto assembly and align the hinge screws to the screw embossments.
2. Replace the two M2.5 x 5-mm screws.



3. Replace the handle (see [Replacing the Handle](#))
4. Follow the procedures in [After Working on Your Computer](#).